

CATALOGUE DES PRODUITS



Danish Design.
Danish Quality.

Fixation pour
plaques de plâtre et
brique

Fixation pour pierre
fissurée et poreuse

Fixation pour béton
fissuré en brique

Fixation pour béton

Foret



Création danoise, qualité danoise

Depuis les années 50, Expandet fut une des plus grandes marques à succès dans le domaine de la fixation dans le béton, la brique et l'industrie du bois.

L'usine (d'une superficie de 4.000m²) située au Danemark produit des fixations et des ancrages de haute qualité en de très grands volumes, assurant ainsi des prix compétitifs, une production flexible pour des produits innovants afin de répondre continuellement aux demandes des professionnels de la construction et aussi à nos partenaires revendeurs.

En utilisant un code de couleur unique et un développement de produits avancé, la marque Expanded se démarque de tous les autres concurrents.

En contact direct avec l'industrie de la construction durant de nombreuses années, Expandet a continué à développer des produits nouveaux et innovatifs, créés pour satisfaire à la fois l'évolution des applications et les attentes des clients.





En 1953, Expandet développa et produisa la première cheville thermoplastique en PVC au monde! Résistant aux charges les plus hautes jamais vues dans le marché, la cheville murale Expandet continue toujours d'être produite dans la même usine Expandet et est toujours à ce jour le produit connaissant le plus grand succès.

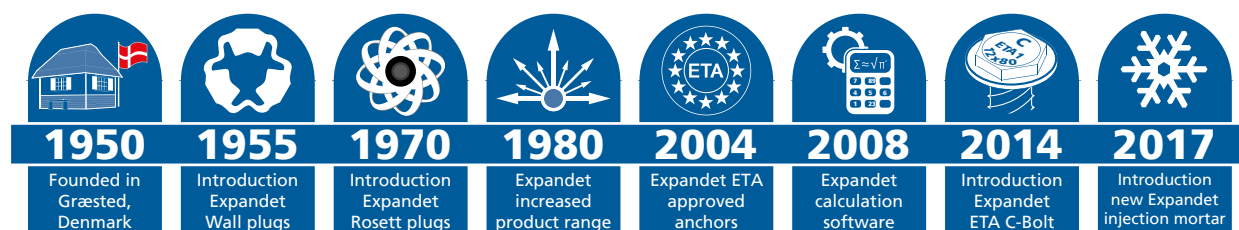

De récents exemples d'initiatives de développement Expandet inclus la nouvelle série Xtreme Pro dans l'ancrage chimique ainsi que l'innovatif C-bolt, un ancrage pour le béton conçu pour des fixations rapides à forte charge.



	EN	NL	DE	FR	DK
	Technical abbreviations	Technische afkortingen	Technische Abkürzung	Abréviation techniques	Tekniske forkortelser
L [mm]	Anchor length	Anker lengte	Ankerlänge	Longueur de l'ancrage	Ankerlængde
d₀ [mm]	Drill diameter	Boorgatdiameter	Bohrlochdurchmesser	Diamètre de forage	Boordiameter
d_s	Rebar diameter	Wapeningsdiameter	Bewehrungsdurchmesser	Diamètre des barres d'armature	Armeringsjern Diameter
d	Anchor diameter	Ankerdiameter	Ankerdurchmesser	Diamètre de l'ancrage	Ankerdiameter
h [mm]	Thickness of concrete member (min.)	Dikte basismateriaal	Bauteildicke	Épaisseur matériau de base	Minimum Betontykkelse
h_i [mm]	Drill depth (min.)	Boorgatdiepte	Bohrlochtiefe	Profondeur du trou de forage	Borddybde
h_{ef} [mm]	Effective anchorage depth	Effectieve plaatsingsdiepte	Effektive Verankerungstiefe	Profondeur de scellement effective	Effektiv forankringsdybde
h_{min} [mm]	Thickness of submaterial (min.)	Dikte van submateriaal	Bauteilstärke (min.)	Épaisseur du matériau (min.)	Materiale højde (min.)
h_{nom} [mm]	Embedment depth (min.)	Plaatsingsdiepte	Verankerungstiefe	Profondeur d'ancrage	Sættedybde (min.)
h_f [mm]	Cavity (min.)	Minimale holle ruimte	Hohlraum (min)	Espace (min.)	Hulrum (min.)
t_{fix} [mm]	Thickness of fixture (max.)	Klembereik	Anbauteildicke	Épaisseur de pièce à fixer	Emnetykkelse (max.)
N_{rec} [kN]	Recommended tension load	Aanbevolen trekbelasting	Empfohlene Zuglast	Charge recommandée de traction	Anbefalet direkte træk
V_{rec} [kN]	Recommended shear load	Aanbevolen afschuifbelasting	Empfohlene Querlast	Charge recommandée de cisaillement	Anbefalet tværtræk
F_{rec} [kN]	Recommended load capacities	Aanbevolen laad capaciteit	Empfohlende Tragfähigkeit	Capacité de charge recommandée	Anbefalede bæreevne
N_{Rd} [kN]	Design resistance, tension	Goedgekeurde trekbelasting	Zugtragfähigkeit, zug	Résistance de calcul, Charge de traction	Regningsmæssigt direkte træk
N_{Rd} [kN]	Design resistance, shear	Goedgekeurde afschuifbelasting	Abscherkraft, querkraft	Résistance de calcul, Charge de cisaillement	Regningsmæssig forskydningsbæreevne
F_{Rd} [kN]	Design resistance	Goedgekeurde belasting	Bemessungswiderstand	Résistance de calcul	Regningsmæssige bæreevne

	Icon legend	Icoonlegenda	Symbol-Legende	Légende de l'icône	Ikon oversigt
	Thickness of board	Dikte plaatwerk	Plattenstärke	Épaisseur du panneau	Pladetykkelse
	Drill diameter	Boordiameter	Bohrdurchmesser	Diamètre de forage	Bordiameter
	Length of screw	Schroeflengte	Schraubenlänge	Longueur de la vis	Skruelængde or skruer længde
	Screw diameter	Diameter	Schraubendurchmesser	Diamètre de la vis	Skruediameter or skruer diameter
	Head diameter	Kopdiameter	Kopfdurchmesser	Diamètre de la tête	Hoveddiameter or hoved diameter
	Pcs. per box	Aantal stuks per box	Stück per Schachtel	Nombre par boîte	Stk. pr. æske
	Torx, tx	Torx	Torx, TX	Torx, TX	Torx, TX
	Pozidrive, pz	Pozidrive	Pozidrive, PZ	Posidrive, PZ	Pozidrive, PZ

	Remarks	Opmerking	Bemerkung	Remarque	Bemærkning
Ref# 1	Load capacity is valid for a single anchor without influence from edge distances and/or spacing.	Belasting geldt voor een enkele plug. Zonder invloeden van randafstanden en/of muurafstanden.	Die Tragfähigkeit ist bemessen für die Einzelverankerung, ohne Berücksichtigung von Rand- und oder Achsabstände.	La valeur de charge est valable pour un seul ancrage sans influence sur la distance du bord et/ou de l'espacement	Angivne bæreevner gælder for et enkelt anker uden indflydelse fra kantafstand og/ eller indbydes afstand.
Ref# 2	Load capacity is valid for a single anchor in a reated concrete without influence from edge distances and/or spacing.	Belasting geldt voor een enkele plug in gipsbetonblokken. Zonder invloeden van randafstanden en/of muurafstanden	Die Tragfähigkeit ist bemessen für die Einzelverankerung in Gasbeton, ohne Berücksichtigung von Rand- und oder Achsabstände.	La valeur de charge est valable pour un seul ancrage dans le béton armé sans influence sur la distance du bord et/ou de l'espacement	Angivne bæreevner gælder for et enkelt anker i porebeton uden indflydelse fra kantafstand og/ eller indbydes afstand.
Ref# 3	Load capacity is valid for a single anchor in gypsum board without influence from edge distances and/or spacing.	Belasting geldt voor een enkele plug in gipsplaat. Zonder invloeden van randafstanden en/of muurafstanden	Die Tragfähigkeit ist bemessen für die Einzelverankerung in Gipskarton, ohne Berücksichtigung von Rand- und oder Achsabstände	La valeur de charge est valable pour un seul ancrage dans un panneau de plâtre sans influence sur la distance du bord et/ou de l'espacement	Angivne bæreevner gælder for et enkelt anker i gipsplader uden indflydelse fra kantafstand og/ eller indbydes afstand.
Ref# 4	Load capacity is valid for a single anchor in concrete C20/25 without influence from edge distances and/or spacing.	Belasting geldt voor een enkele plug in C20/25 beton. Zonder invloeden van randafstanden en/of muurafstanden	Die Tragfähigkeit ist bemessen für die Einzelverankerung in Beton C20/25, ohne Berücksichtigung von Rand- und oder Achsabstände.	La valeur de charge est valable pour un seul ancrage dans du béton C20/25 sans influence sur la distance du bord et/ou de l'espacement	Angivne bæreevner gælder for et enkelt anker i Beton C20/25 uden indflydelse fra kantafstand og/ eller indbydes afstand.
Ref# 5	Load capacity is valid for a single plug together with maximum permitted screw, without influence from edge distances and/or spacing.	Belasting geldt voor een enkele plug samen met een maximaal toegestane schroefmaat. Zonder invloeden van randafstanden en/of muurafstanden	Die Tragfähigkeit ist bemessen für den Einzeldübel, in Verbindung mit der höchstzulässigen Schraube, ohne Berücksichtigung von Rand- und oder Achsabstände	La valeur de charge est valable pour une seule cheville avec la plus longue vis possible, sans influence sur la distance du bord et/ou de l'espacement	Angivne bæreevner gælder for et enkelt plik med størst mulig anbefalet skrue, uden indflydelse fra kantafstand og/ eller indbydes afstand.

Page	ETA Option 1		ETA Option 7		ETA Part 6	ETA Nylon Anchor	ETA on masonry	Aerated concrete	Concrete	Concrete block	Hollow concrete block	Hollow brick	Solid brick	Drywall	Load < 1 kN	1 kN - 15 kN	Load > 15 kN	Fire tested
	ETA Option 1	ETA Option 7	ETA Option 7	ETA Option 7	ETA Part 6	ETA Nylon Anchor	ETA on masonry	Aerated concrete	Concrete	Concrete block	Hollow concrete block	Hollow brick	Solid brick	Drywall	Load < 1 kN	1 kN - 15 kN	Load > 15 kN	Fire tested
Super with Long Expansion	2							●	●	●			●	●	●	●		
RDD Frame Fixing	3							●	●	●			●	●	●	●		
Aerated Concrete Nail	5							●							●	●		
LB Nylon / LB Metal	6							●							●	●		
Special plug	8							●		●	●	●	●		●			
Rosett	10								●	●	●	●	●	●	●			
Light Rosett	13							●	●	●	●	●	●	●	●			
Jet-Drive	14													●	●			
Mini Driva	15							●						●	●			
Plasterboard-Clip	17													●	●			
Metal Cavity Anchor	18													●	●			
Spring Toggle Anchor	20													●	●			
Metal Toggle Anchor	21													●	●			
MFA	22					●	●	●	●	●			●	●	●	●		●
Super Nylon Plug	26								●	●			●		●			●
Nail Anchor	28								●	●			●	●	●			
Multi Plug	31							●	●	●	●	●	●		●			
Universal Plug	32							●	●	●	●	●	●		●			
Metal Frame Fixing	33								●	●			●	●	●			
Concrete Screw	34								●	●			●	●	●			
Wallplug	38								●	●			●		●	●		
Express Nail	40								●	●			●	●	●			
Alum-Nail-in Anchor	41								●	●			●	●	●			
Brass Anchor	42								●	●			●	●	●	●		
Isoplug with Expansion	43								●	●			●	●	●			
Isoplug	44								●	●			●	●	●			
Isoplug Metal	46								●	●			●	●	●			●
Long Isoplug	47								●	●			●	●	●			
Expansion Bolt	48								●	●			●	●	●	●	●	●
ESI Xtreme Pro	52	●					●	●	●	●	●	●	●	●	●	●	●	●
EVL Xtreme Pro Winter	55	●					●	●	●	●	●	●	●	●	●	●	●	●
ESP Pro	58		●				●	●	●	●	●	●	●	●	●	●	●	●
C-Bolt with Flange	74	●					●	●	●	●			●		●	●	●	●
MMS Concrete Bolt	76	●					●	●	●	●			●		●	●	●	●
Through Bolt EXGII	82		●						●	●					●	●	●	●
Through Bolt BZ	86	●							●	●					●	●	●	●
Heavy Duty Anchor	89	●							●	●					●	●	●	●
Drop-in Anchor	91		●	●					●	●			●		●	●	●	●
Concrete Hammer Rivet	95				●				●	●			●		●			●
Ceiling Anchor	96								●	●			●		●			

Fixings for Porous materials & Hollow Brick	2
Drywall Fixings	10
Fixings for Concrete and Brick	22
Fixings for Concrete	74
Drills	98

Bevestiging voor poreus materiaal en holle baksteen
 Befestigung für Baustoffe mit porigem Gefüge und Hohllochziegeln
 Fixation pour plaques de plâtre et brique
 Fastgørelse i porebeton, Leca og hulsten

2

Bevestigingen voor gipsplaten
 Befestigung für Gipskartonplatten
 Fixation pour pierre fissurée et poreuse
 Fastgørelse i gipsplader og andre pladematerialer

10

Bevestigingen in beton en baksteen
 Befestigung für Beton und Ziegel
 Fixation pour béton fissuré en brique
 Fastgørelse i massiv musten og beton

22

Bevestigingen in beton
 Befestigung für Beton
 Fixation pour béton
 Fastgørelse i beton

74





Boren
 Bohrer
 Foret
 Bor

98

Super plug with Long Expansion

Super plug met lange expansie
 Super Langdübel
 Super avec longue Expansion
 Super med Dobbelt ekspansjon







			
hollow brick	aerated concrete	lightweight blocks	porous walls

FIXINGS FOR POROUS MATERIALS & HOLLOW BRICK

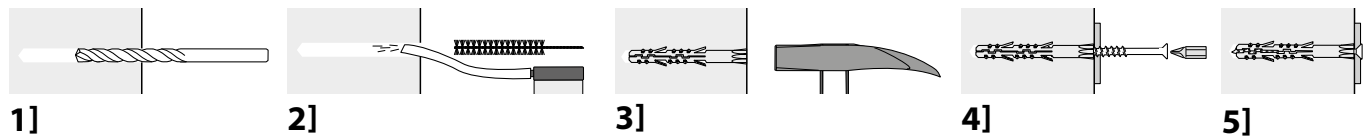
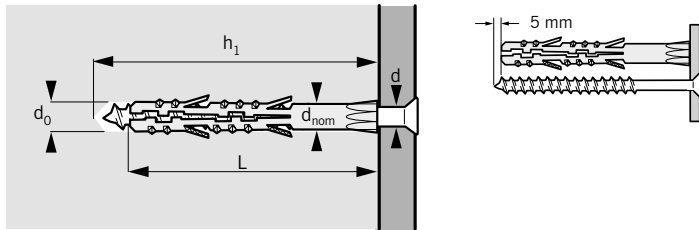
Type	Load capacities							
	Aerated concrete PP4		Aerated concrete PP2		Leca 3 N/mm ²		Hollow brick 22 N/mm ²	
	Recommended tension load N _{Rd}	Recommended shear load V _{Rd}	Recommended tension load N _{Rd}	Recommended shear load V _{Rd}	Recommended tension load N _{Rd}	Recommended shear load V _{Rd}	Recommended tension load N _{Rd}	Recommended shear load V _{Rd}
6 x 55	0,24	0,49	0,08	0,18	-	-	0,25	0,20
8 x 65	0,53	0,70	0,24	0,35	0,40	0,46	0,80	0,68
10 x 80	0,72	0,82	0,30	0,44	0,71	0,85	1,30	0,91
12 x 95	0,98	1,14	0,57	0,66	1,20	1,02	1,70	1,15

Conditions on load capacity: See page I, ref# 5







TYPE	CHIPBOARD SCREW	WOOD SCREW	d ₀ [mm]	h ₁ [mm]	ART. NR.		EAN 13
							
6 x 55	4,0 - 5,0	-	6	65	260655	100	5708620026558
8 x 65	5,5 - 6,0	6	8	75	260865	50	5708620026565
10 x 80	-	8	10	90	261080	25	5708620026572
12 x 95	-	10	12	105	261295	20	5708620026992

RDD Frame Fixing

RDD kozijnplug
 RDD Rahmendübel
 Cheville pour chassis RDD
 RDD Karmpløk



				
solid brick	hollow brick	concrete	hollow concrete block	aerated concrete

Type	Load capacities			
	Concrete C 12/15	Concrete > C12/15	Concrete C 12/15	Concrete > C12/15
	w/ zinc plated screw		w/ stainless steel screw (Inox 316)	
	Design load, tension N_{Rd} (kN)	Design load, shear N_{Rd} (kN)	Design load, tension N_{Rd} (kN)	Design load, shear N_{Rd} (kN)
RDD8	0,67	3,8	1,1	1,3
RDD10	1,1	4,3	1,7	3,8

Conditions on load capacity: See page I, ref# 4

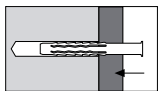
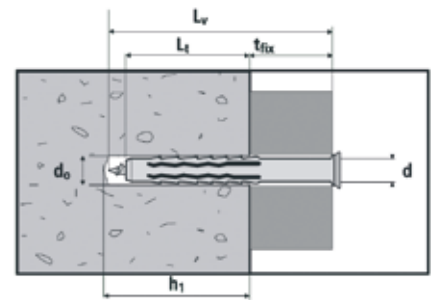



1]



2]





TYPE	d_0 [mm]	h_{ef} [mm]	t_{fix} [mm]	ART. NR.			EAN 13
RDD880TX	8	70	10	E1101	50	TX30	
RDD8100TX	8	70	30	E1102	50	TX30	
RDD8120TX	8	70	50	E1103	50	TX30	
RDD10080TX	10	70	10	E1104	50	TX40	
RDD10100TX	10	70	30	E1105	50	TX40	
RDD10120TX	10	70	50	E1106	50	TX40	
RDD10140TX	10	70	70	E1107	25	TX40	
RDD10160TX	10	70	90	E1108	25	TX40	
RDD10200TX	10	70	130	E1109	25	TX40	
RDD10240TX	10	70	170	E1110	25	TX40	
RDD10260TX	10	70	190	E1111	25	TX40	

RVS

RDD1080TXI	10	70	10	E1112	50	TX40	
RDD10100TXI	10	70	30	E1113	50	TX40	
RDD10120TXI	10	70	50	E1114	50	TX40	
RDD10140TXI	10	70	70	E1115	25	TX40	
RDD10160TXI	10	70	90	E1116	25	TX40	
RDD10200TXI	10	70	130	E1117	25	TX40	

RDD frame fixing



TYPE	d_0 [mm] 	h_{ef} [mm]	t_{fix} [mm]	ART. NR.			EAN 13
HEX HEAD							
RDD1080SK	10	70	10	E1118	50	SW13	
RDD10100SK	10	70	30	E1119	50	SW13	
RDD10120SK	10	70	50	E1120	50	SW13	
RDD10140SK	10	70	70	E1121	25	SW13	
RDD10160SK	10	70	90	E1122	25	SW13	
RDD10200SK	10	70	130	E1123	25	SW13	
RDD10240SK	10	70	170	E1124	20	SW13	
RDD10260SK	10	70	190	E1125	20	SW13	

Aerated Concrete Nail

Cellenbetonnagel
 Porenbetonnagel
 Clou pour béton cellulaire
 Porebeton Søm

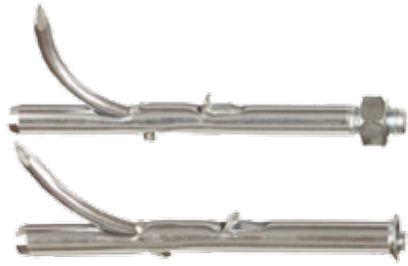

G

K

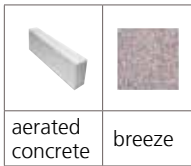

Type	Load capacities	
	Aerated Concrete PP2	Aerated Concrete PP4
DIAMETER	Recommended Tension Load N_{rec} (kN)	Recommended Tension Load N_{rec} (kN)
6 x 60	0,06	0,14
6 x 80	0,06	0,14
6 x 130	0,06	0,14
8 x 90	0,30	0,60
8 x 115	0,30	0,60
8 x 130	0,30	0,60
8 x 145	0,30	0,60

Conditions on load capacity: See page I, ref# 2

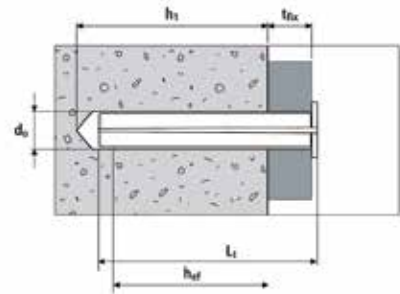

FIXINGS FOR POROUS MATERIALS & HOLLOW BRICK



TYPE	d_0 [mm]	h_1 [mm]	t_{fix} [mm]	ART. NR.		EAN 13
6 x 60 G	6	50	10	400528	100	
6 x 90 G	6	50	40	400529	100	
6 x 130 G	6	50	80	400530	100	
8 x 90 G	8	80	10	400531	50	
8 x 115 G	8	80	35	400532	50	
8 x 130 G	8	80	50	400533	50	
6 x 60 K	6	50	10	400534	100	
6 x 90 K	6	50	40	400535	100	
6 x 130 K	6	50	80	400536	100	
8 x 90 K	8	80	10	400538	50	
8 x 115 K	8	80	35	400539	50	
8 x 130 K	8	80	50	400540	50	
8 x 145 K	8	80	65	381670	50	

LB Nylon / LB Metal anchor





LB Gasbetonanker

LB Gasbetondübel

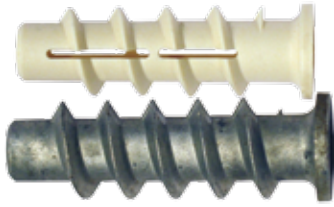
Cheville LB pour béton cellulaire

LB Nylon / LB Metal



			
breeze	aerated concrete	lightweight blocks	two- and three-layer plasterboards

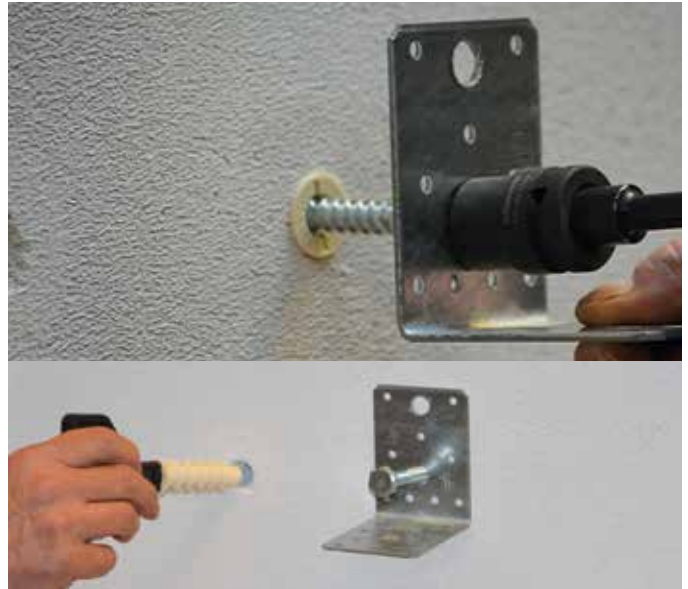

Type	Load capacities			
	Aerated concrete PP4		Aerated concrete PP2	
	N_{Rd}	V_{Rd}	N_{Rd}	V_{Rd}
	Recommended tension load kN	Recommended shear load kN	Recommended tension load kN	Recommended shear load kN
LB4	0,43		0,21	
LB6	0,60	0,91	0,29	0,56
LB8	0,90	0,97	0,43	0,66
LB10	0,92	1,10	0,64	0,71

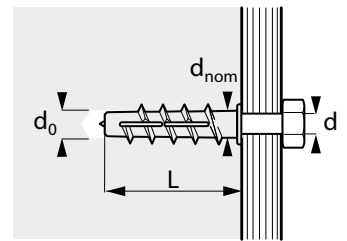

Conditions on load capacity: See page I, ref# 2

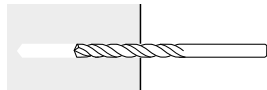

1]

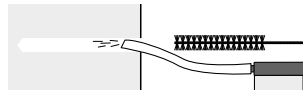

2]

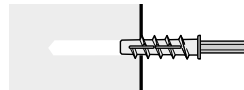



3]





4]

Nylon

TYPE	WOOD SCREW 	d_0 [mm] 	HEXAGON KEY	ART. NR.		EAN 13
10 x 50	4,0 - 4,5	10	10	661050/4	25	5708620066202
10 x 50	6,0	10	10	661050/6	25	5708620068091
12 x 60	8,0	12	12	661260	20	5708620068077
14 x 70	10,0	14	14	661470	10	5708620068084

Metal

TYPE	MACHINE SCREW 	d_0 [mm] 	HEXAGON KEY	ART. NR.		EAN 13
10 x 50	* 6,0	10	10	651050	25	5708620066141
12 x 60	* 8,0	12	12	651260	20	5708620066158
14 x 70	* 10,0	14	14	651470	10	5708620066165

* Available on request

FIXINGS FOR POROUS MATERIALS & HOLLOW BRICK

Aerated Concrete setting tool for LB

Gasbetonanker installatiegereedschap voor LB

Gasbetondübel Setzwerkzeug für LB

Outil d'installation pour cheville LB pour béton cellulaire

Gasbeton anchor setting tool for LB



TYPE

For LB 10 mm
For LB 12 mm
For LB 14 mm

ART. NR.		EAN 13
----------	---	--------

661000EX	1	5708620068145
661200	1	5708620068107
661400	1	5708620068114

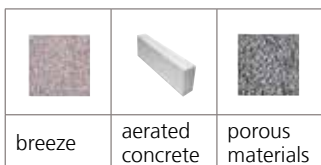

Special plug



Type	Load capacities
DIMENSION	F_{rec}
	Recommended Load capacities kN
G 6 x 50	0,30
G 8 x 55	0,45

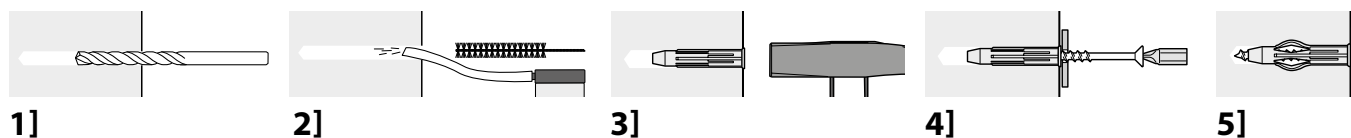
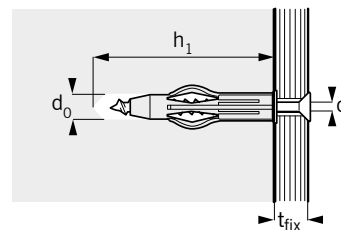
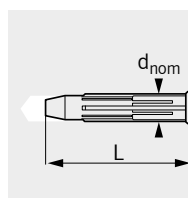
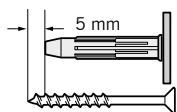



Conditions on load capacity: See page I, ref# 5



TYPE		d_0 [mm] 	h_1 [mm]	ART. NR.		EAN 13
G 6 x 50	4,0 - 5,0	6	55	660650	100	5708620066011
G 8 x 55	5,5 - 6,0	8	60	660855	50	5708620066028

Rosett



			
plaster-boards	gypsum fiber boards	chip-boards	cavity walls



DRYWALL FIXINGS



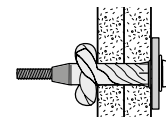
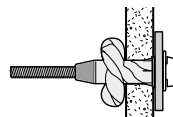
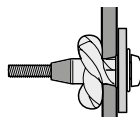
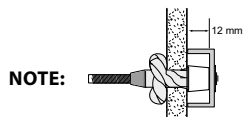
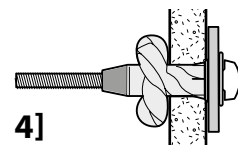
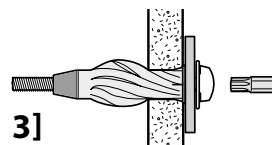
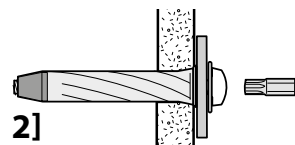
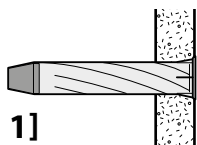
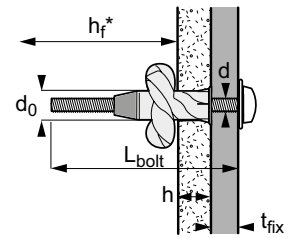
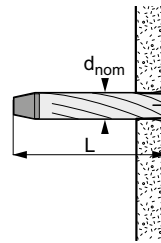

Type	Load capacities	
	N_{rec} Recommended tension load kN	V_{rec} Recommended shear load kN
GREY (1 layer)	0,20	0,35
BLUE (1 layer I)	0,38	0,50
RED (2 layer)	0,70	0,85
HOOK (1 og 2 layer)	0,20	0,35
HOOK (1 og 2 layer)	0,20	0,35
EYE (1 og 2 layer)	0,20	0,35

Conditions on load capacity: See page I, ref# 2



Rosett, Red







TYPE		d_0 [mm]		t_{fix} [mm]	ART. NR.			EAN 13
Red without screw	18-30	10	-	-	410060	25	TX 25	5708620046174
Red Pan 5 x 65/12	18-30	10	65	12	410160EX	25	TX 25	5708620046181
Red Pan 5 x 90/38	18-30	10	90	38	410860	25	TX 25	5708620046259
Red Spacer 5 x 75/12	18-30	10	75	12	410260	25	TX 25	5708620046198
Red counters 5 x 75/23	18-30	10	75	23	410660	25	TX 25	5708620046235
Red counters 5 x 90/38	18-30	10	90	38	410760	25	TX 25	5708620046242
Red Hook	18-30	10	55	-	410360	25		5708620046204
Red SQ. Hook	18-30	10	55	-	410460	25		5708620046211
Red Eye	18-30	10	55	-	410560	25		5708620046228
MEGA PACK								
Red Pan 5 x 65/12	18-30	10	65	12	430160	50	TX 25	5708620046471
Red counters 5 x 75/23	18-30	10	75	23	430660	250	TX 25	5708620046488
BULK CARTON								
Red Pan 5 x 65/12	18-30	10	65	12	410100EX	1.000	TX 25	5708620047096
Red counters 5 x 75/23	18-30	10	75	23	410600	800	TX 25	5708620047058

DRYWALL FIXINGS



Rosett, Blue



TYPE		d_0 [mm]		t_{fix} [mm]	ART. NR.			EAN 13
Blue without screw	9-18	10	-	10	410061	25	TX 25	5708620046099
Blue Pan 5 x 55/15	9-18	10	55	15	410161	25	TX 25	5708620046105
Blue Pan 5 x 80/40	9-18	10	80	40	410861	25	TX 25	5708620046266
Blue Spacer 5 x 65/12	9-18	10	65	12	410261	25	TX 25	5708620046112
Blue counters 5 x 65/25	9-18	10	65	25	410661	25	TX 25	5708620046150
Blue counters 5 x 80/40	9-18	10	80	40	410761	25	TX 25	5708620046167
Blue Hook	9-18	10	55	-	410361	25		5708620046129
Blue Sq. Hook	9-18	10	55	-	410461	25		5708620046136
Blue Eye	9-18	10	55	-	410561	25		5708620046143
MEGA PACK								
Blue Pan 5 x 55/15	9-18	10	55	15	430161	50	TX 25	5708620046440
Blue counters 5 x 65/25	9-18	10	65	25	430661	50	TX 25	5708620046464
BULK CARTON								
Blue Pan 5 x 55/15	9-18	10	55	15	410101	1.200	TX 25	5708620047041
Blue counters 5 x 65/25	9-18	10	65	25	410601	1.200	TX 25	5708620047102





5 mm machine screw for Rosett



TYPE	ART. NR.			EAN 13
5 x 80 Pan	000005T	100	TX 25	5708620046754
5 x 80 counters.	000010T	100	TX 25	5708620046778
5 x 90 Pan	000009T	100	TX 25	5708620046761
5 x 90 counters.	000011T	100	TX 25	5708620046785

Rosett, Grey







TYPE		d_0 [mm] 		t_{fix} [mm]	ART. NR.			EAN 13
Grey without screw	3-10	10	-	10	410064	25	PZ 2	5708620046013
Grey Pan 5 x 40/10	3-10	10	40	10	410164	25	PZ 2	5708620046020
Grey Spacer 5 x 50/12	3-10	10	50	12	410264	25	PZ 2	5708620046037
Grey counters. 5 x 40/10	3-10	10	40	10	410664	25	PZ 2	5708620046075
Grey Hook	3-10	10	45	-	410364	25		5708620046044
Grey Sq. Hook	3-10	10	45	-	410464	25		5708620046051
Grey Eye	3-10	10	45	-	410564	25		5708620046068



Light Rosett

Lichte Rosett
Rosett, leicht
Rosette légère
Let Rosett



			
plaster-boards	gypsum fiber boards	chip-boards	cavity walls



DRYWALL FIXINGS

Type	Load capacities	
DIMENSION	N_{rec}	V_{rec}
	Recommended tension load kN	Recommended shear load kN
Red, 6 x 30 (1 layer)	0,10	0,15
Red, 6 x 35 (1 layer)	0,20	0,25
Red, 6 x 50 (1 layer)	0,25	0,30
Blue, 8 x 45 (2 layers)	0,20	0,35
Blue, 8 x 55 (2 layers)	0,30	0,40

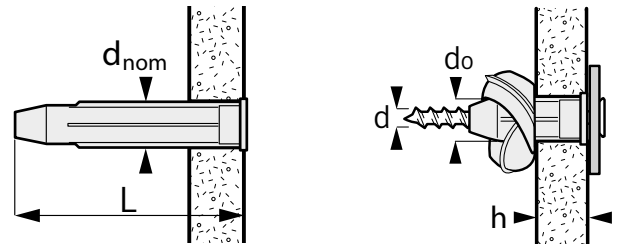

Conditions on load capacity: See page I, ref# 3

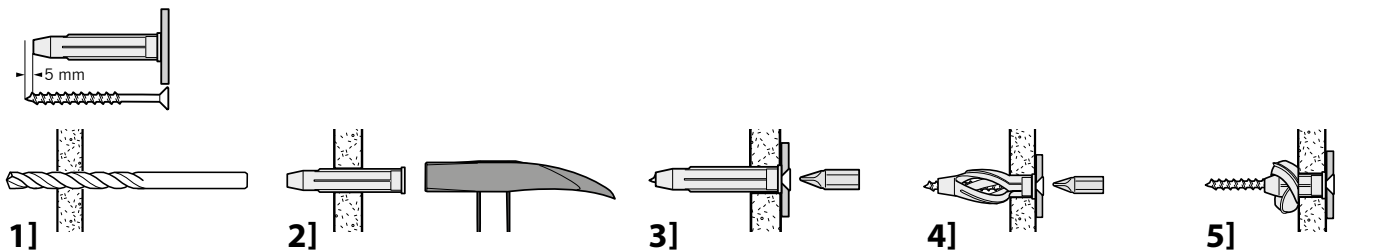

Red

TYPE		d_0 [mm]	
------	---	------------	---

FOR ONE LAYER OF PLASTERBOARD

6 x 30	3-9	6	3,5-4,5
6 x 35	9-13	6	3,5-4,5

FOR ONE LAYER OF PLASTERBOARD

6 x 50	26	6	3,5-4,5
--------	----	---	---------

ART. NR.		EAN 13
----------	---	--------

360630	100	5708620036014
360635	100	5708620036021

360650	100	5708620036038
--------	-----	---------------

Blue

TYPE		d_0 [mm]	
------	---	------------	---

FOR ONE LAYER OF PLASTERBOARD

8 x 45	13-18	8	5,0-6,0
--------	-------	---	---------

FOR ONE LAYER OF PLASTERBOARD

8 x 55	26	8	5,0-6,0
--------	----	---	---------

ART. NR.		EAN 13
----------	---	--------

360845	100	5708620036045
--------	-----	---------------

360855	100	5708620036052
--------	-----	---------------

Jet-Drive gypsum board anchor

Jet-Drive gipsplaatplug
 Jet-Drive Gipskartondübel
 Jet-Drive cheville autoperceuse pour plaque de plâtre
 Jet Drive, skruve anker til gips

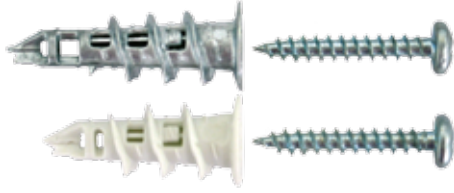

DRYWALL FIXINGS

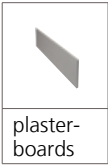

Type		Load capacities	
DIMENSION		N_{rec}	V_{rec}
		Recommended tension load kN	Recommended shear load kN
Jet-Drive Metal	14 x 32	0,10 (0,14)	0,18
Jet-Drive Nylon	14 x 32	0,10	0,10

Conditions on load capacity: See page I, ref# 3

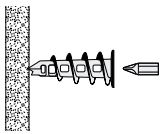
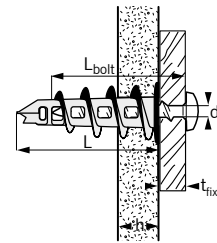

1]

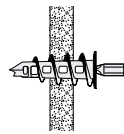

2]

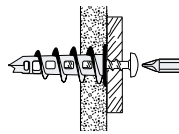

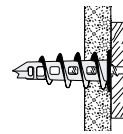

3]

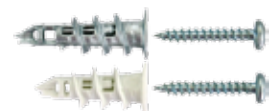

4]



TYPE			t_{fix} [mm]	ART. NR.		EAN 13
Jet-Drive Metal 14 x 32	9-26			961100	100	5708620099828
Jet-Drive Metal* 14 x 32	9-26	30	15	961000	100	5708620096841
Jet-Drive Nylon* 14 x 32	9-13	30	10	961001	100	5708620096858

* Supplied with screw: 4,5 x 30 mm.

Quick Driva and Mini Driva screw anchor

Quick Driva en Mini Driva schroefanker
 Quick Driva und Mini Driva Dübel mit Schraube
 Vis multi matériaux Quick Driva et Mini Driva
 Quick Driva and Mini Driva skruueanker til gips



DRYWALL FIXINGS

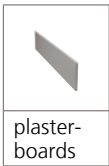

plaster-boards

Type	Load capacities
DIMENSION	N_{rec}
	Recommended tension load kN
Metal Quick Driva	0,03
Nylon Mini Driva	0,03

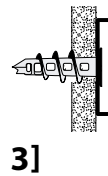
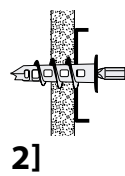
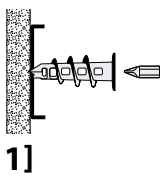

Conditions on load capacity: See page I, ref# 3

QUICK DRIVA:

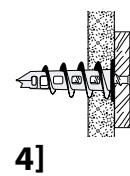
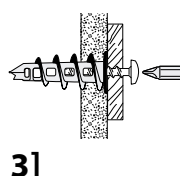
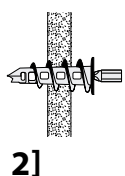
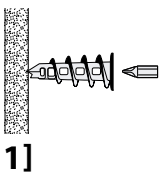

MINI DRIVA:



TYPE			t_{fix} [mm]	ART. NR.		EAN 13
Metal Quick Driva	9-26		3	961120	200+PH 1 bit	5708620096704
Nylon Mini Driva *	9-13	3,0	12	961011	250	5708620096889

* Supplied with Poz.2 screw

Nylon Cavity Anchor with screw

Nylon hollewandanker met schroef
 Nylon Hohlräumdübel mit Schraube
 Cheville pour paroi creuse avec vis
 Nylon Gips-Pløk med skrue







DRYWALL FIXINGS

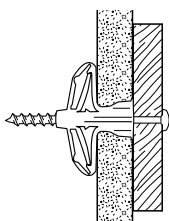

Type	Layers	Load capacities
DIMENSION	1 or 2 layer (12-24 mm)	N_{rec}
		Recommended tension load kN
4 x 60	1	0,12
4 x 60	2	0,17

Conditions on load capacity: See page I, ref# 3



TYPE		d_0 [mm] 		t_{fix} [mm]	ART. NR.		EAN 13
4 x 60 *	12- 24	10	60	15	900099	50	5708620200392

* Screw dimension

Plasterboard-Clip

Gipsplaat-Klem
 Gipskartonplatten-Klammer
 Plaque de plâtre-agrafe
 Gips-Clip



DRYWALL FIXINGS



Type	Load capacities
DIMENSION	N_{rec}
	Recommended tension load kN
12,5 x 35	0,05

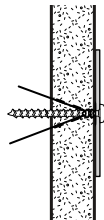

Conditions on load capacity: See page I, ref# 3



TYPE

12,5 x 35 *

* Use 3,5 - 4,5 mm woodscrew

	ART. NR.		EAN 13
3,5 - 4,5	912535	100	5708620201771

Metal Cavity Anchor

Metalen hollewandanker

Hohlraum-Metalldübel

Cheville à expansion pour murs creux

Metal Gips-Pløk



DRYWALL FIXINGS

			
plaster-boards	gypsum fiber boards	chip-boards	cavity walls

Type	Load capacities	
	N_{rec} Recommended tension load kN	V_{rec} Recommended shear load kN
4 x 32	0,15	0,20
4 x 45	0,15	0,40
5 x 52	0,18	0,60
5 x 65	0,20	0,50
5 x 80*	0,20	0,50
6 x 52	0,18	0,30
6 x 65	0,20	0,50
6 x 80*	0,30	0,50
8 x 65	0,30	0,50

Conditions on load capacity: See page I, ref# 3

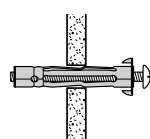
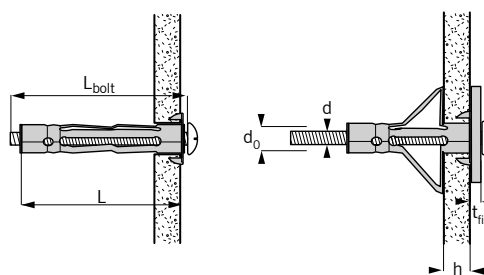

1]

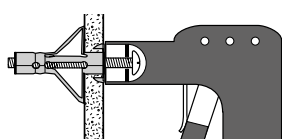

2]

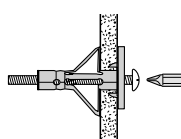

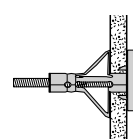

3]



4]



TYPE		d_o [mm]	t_{fix} [mm]	ART. NR.		EAN 13
M4 x 32	5-14	8	37	904032	100	5708620099378
M4 x 45	18-26	8	49	904045EX	100	5708620099385
M5 x 52	3-16	10	57	905052	100	5708620099392
M5 x 65	22-32	10	70	905065	100	5708620099408
M5 x 80	32-45	10	85	905080EX	100	5708620099415
M6 x 52	3-16	12	57	906052	100	5708620099965
M6 x 65	23-32	12	70	906065	50	5708620099972
M6 x 80	32-45	12	85	906080	50	5708620099453
M8 x 65	23-32	13	70	908065	50	5708620201986

Hollow Wall Anchor setting tool for M4, M5, M6

Hollewandanker installatietang voor M4, M5, M6

Hohlraum-Metalldübelzange für M4, M5, M6

Outil d'installation pour cheville à expansion pour M4, M5, M6

Montagetang til M4, M5, M6



TYPE

Installing tool for M4, M5, M6

ART. NR.		EAN 13
----------	---	--------

910100	1	5708620099422
--------	---	---------------

DRYWALL FIXINGS

Hollow Wall Anchor setting tool for M4, M5, M6, M8

Hollewandanker installatietang voor M4, M5, M6, M8

Hohlraum-Metalldübelzange für M4, M5, M6, M8

Outil d'installation pour cheville à expansion pour M4, M5, M6, M8

Montagetang til M4, M5, M6, M8



TYPE

Installing tool for M4, M5, M6, M8

ART. NR.		EAN 13
----------	---	--------

910101	1	5708620203508
--------	---	---------------

Spring Toggle Anchor

Toggle klapanker
Feder-Klappdübel
Cheville à ressort
Fjerderklap-Pløk

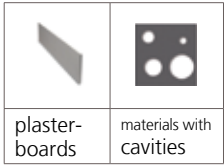

plaster-boards materials with cavities



DRYWALL FIXINGS

Type	Load capacities
DIMENSION	N_{rec}
	Recommended tension load in 13 mm Plasterboard kN
With nut and washer	
3 x 85	0,20
4 x 90	0,25
With hook	
3 x 70	0,03
4 x 70	0,10
With cap nut	
3 x 85	0,20
4 x 90	0,25

Conditions on load capacity: See page 1, ref# 3

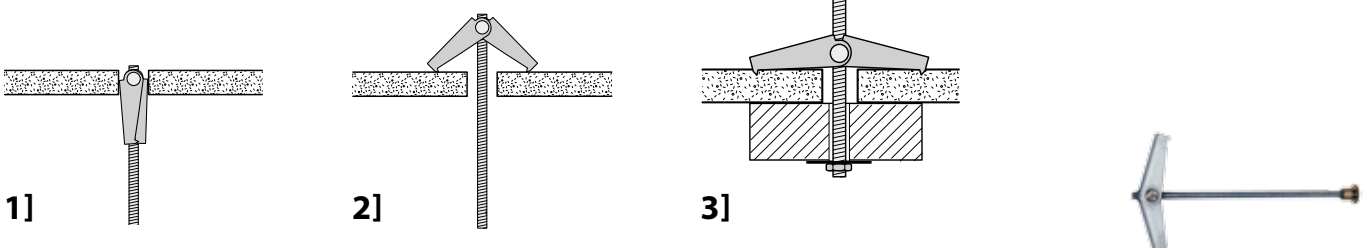
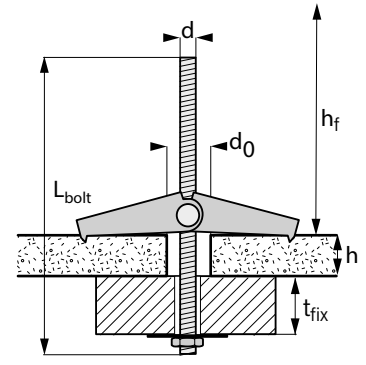



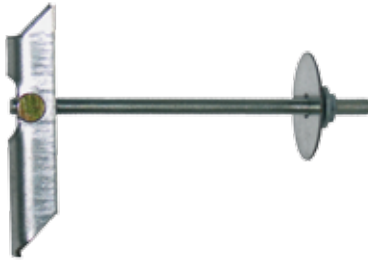

TYPE	h_f [mm]	d_0 [mm]	t_{fix} [mm]	ART. NR.	ART. NR.	ART. NR.	EAN 13
WITH NUT AND WASHER							
M3 x 85	28	12	85	60	903085 M	50	5708620099880
M4 x 90	35	14	90	65	904090 M	50	5708620099897
WITH HOOK							
M3 x 70	28	12	70	30	903070 K	50	5708620099866
M4 x 70	35	14	70	30	904070 K	50	5708620099873
WITH CAP NUT							
M3 x 85	28	12	85	60	903085 T	50	5708620099903
M4 x 90	35	14	90	65	904090 T	50	5708620099910

Metal Toggle Anchor

Toggle klapanker
 Feder Klappdübel
 Cheville à ressort métallique
 Fjerderklap-Pløk



			
plaster-boards	gypsum fiber boards	chip-boards	constructions with cavities



DRYWALL FIXINGS

Type	Load capacities
DIMENSION	N_{rec}
	Recommended tension load kN
With nut and washer	
5 x 100	0,25
6 x 100	0,25
8 x 100	0,25
10 x 100	0,25
10 x 200	0,25
With hook	
5 x 70	0,25

Conditions on load capacity: See page I, ref# 3

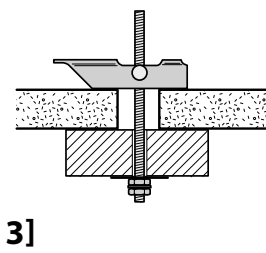
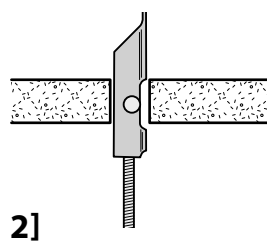
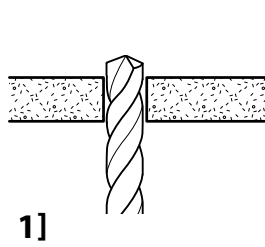
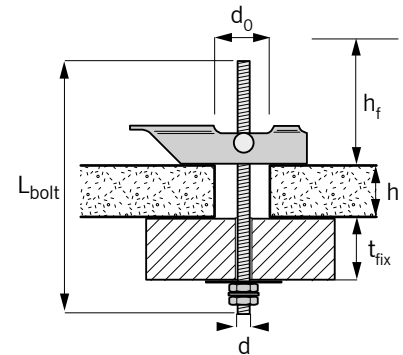

Metal Toggle Anchor M8 and M10 are VdS-approved.

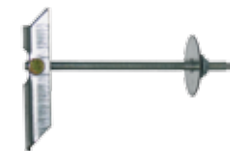





TYPE	h_f [mm]	d_0 [mm]	t_{fix} [mm]	ART. NR.	ART. NR.	ART. NR.	EAN 13
WITH NUT AND WASHER							
M5 x 100	70	16	100	80	905100 M	50	5708620099941
M6 x 100	70	18	100	80	906100 M	50	5708620099958
M8 x 100	85	22	100	70	908100 M	50	5708620200378
M10 x 100	85	25	100	55	910100 M	25	5708620201351
M10 x 200	85	25	200	155	910200 M	25	5708620200385
WITH HOOK							
M5 x 70	70	16	70	30	905070 K	50	5708620099989

MFA with countersunk head

MFA Constructieplug
 MFA Rahmendübel
 Cheville MFA pour ossatures et cadres
 MFA, med undersænket hoved



				
solid brick	hollow brick	cracked concrete	non-cracked concrete	aerated concrete

FIXINGS FOR CONCRETE AND BRICK

Type	Load capacities											
	Aerated concrete PP4		Aerated concrete PP2		Hollow brick 228x108x54 mm 28N/mm ²		Solid brick 19N/mm ²		Concrete C12/15		Concrete ≥ C16/20	
	Design load capacities (kN) F _{Rd}		Design load capacities (kN) F _{Rd}		Design load capacities (kN) F _{Rd}		Recommended load capacities for kN F _{Rd}		Tension load Design load capacities (kN) N _{Rd}		Shear load Design load capacities (kN) V _{Rd}	
10 x 85	0,45	0,15	0,60	0,60	1,0	1,0	1,0	1,0	1,67	3,13	2,22	3,61
10 x 100	0,45	0,15	0,60	0,60	1,0	1,0	1,0	1,0	1,67	3,13	2,22	3,61
10 x 115	0,45	0,15	0,60	0,60	1,0	1,0	1,0	1,0	1,67	3,13	2,22	3,61
10 x 135	0,45	0,15	0,60	0,60	1,0	1,0	1,0	1,0	1,67	3,13	2,22	3,61
10 x 160	0,45	0,15	0,60	0,60	1,0	1,0	1,0	1,0	1,67	3,13	2,22	3,61

Conditions on load capacity: See page 1, ref# 1

DIMENSION	Aerated concrete PP4	Aerated concrete PP2	Hollow brick 228x108x54 mm 28N/mm ²	Solid brick 19N/mm ²	Concrete C12/15	Concrete ≥ C16/20
Minimum thickness of material h _{min}	100	100	108	108	100	100
Minimum spacing, one anchor S _{min}	250	250	250	250	70	50
Minimum edge distance, one anchor C _{min}	100	100	110	110	70	50
Minimum spacing, anchor group perpendicular to edge S1 _{min}	400	400	440	440	70	50
Minimum spacing, anchor group parallel to edge S2 _{min}	200	200	220	220	70	50
Minimum edge distance, anchor group C _{min}	100	100	110	110	70	50

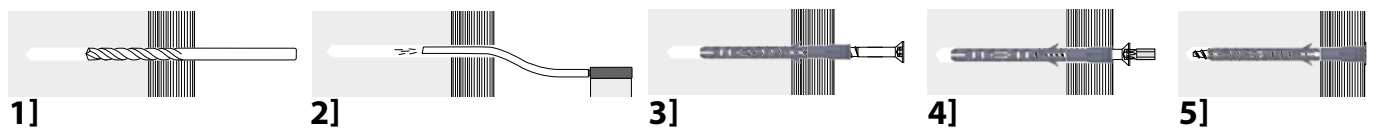
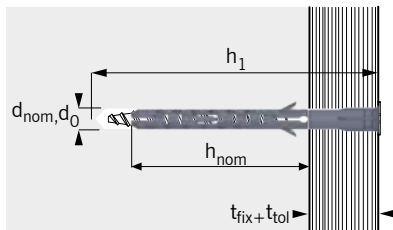

MFA with countersunk head









TYPE	d_0 [mm]	h_1 [mm]	t_{fix} [mm]	ART. NR.		EAN 13
ZINK PLATED						
10 x 85	10	95	20	582085	50	5708620059846
10 x 100	10	110	35	582100	50	5708620059853
10 x 115	10	125	50	582115	50	5708620059860
10 x 135	10	145	70	582135	50	5708620059877
10 x 160	10	170	95	582160	50	5708620059884
HOT DIP GALVANIZED						
10 x 85	10	95	20			
10 x 100	10	110	35	583100	50	5708620059891
10 x 115	10	125	50	583115	50	5708620059907
10 x 135	10	145	70	583135	50	5708620059914
10 x 160	10	170	95	583160	50	5708620059921

MFA with flange head

MFA Constructieplug met cilinder kraag
 MFA Rahmendübel
 Cheville universelle MFA pour ossatures et cadres
 MFA, med flange



					
solid brick	hollow brick	cracked concrete	non-cracked concrete	aerated concrete	plasterboards

FIXINGS FOR CONCRETE AND BRICK

Type	Load capacities							
	Aerated concrete PP4	Aerated concrete PP2	Hollow brick 228x108x54 mm 28N/mm ²	Solid brick 19N/mm ²	Beton C12/15		Beton ≥ C16/20	
DIMENSION	Design load capacities (kN) F _{Rd}	Design load capacities (kN) F _{Rd}	Design load capacities (kN) F _{Rd}	Design load capacities (kN) F _{Rd}	Tension load Design load capacities (kN) N _{Rd}	Shear load Design load capacities (kN) V _{Rd}	Tension load Design load capacities (kN) N _{Rd}	Shear load Design load capacities (kN) V _{Rd}
10 x 70	0,45	0,15	0,60	1,0	1,67	3,13	2,22	3,61
10 x 85	0,45	0,15	0,60	1,0	1,67	3,13	2,22	3,61
10 x 100	0,45	0,15	0,60	1,0	1,67	3,13	2,22	3,61
10 x 115	0,45	0,15	0,60	1,0	1,67	3,13	2,22	3,61
10 x 135	0,45	0,15	0,60	1,0	1,67	3,13	2,22	3,61
10 x 160	0,45	0,15	0,60	1,0	1,67	3,13	2,22	3,61

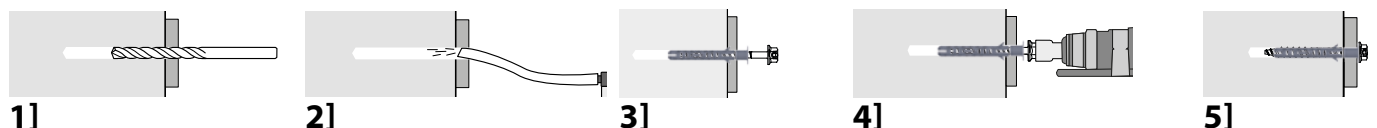
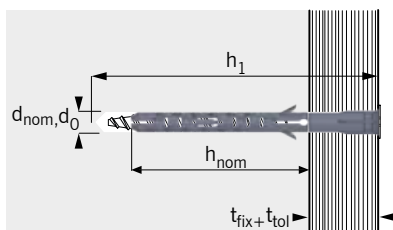

Conditions on load capacity: See page I, ref# 1

DIMENSION	Aerated concrete PP4	Aerated concrete PP2	Hollow brick 228x108x54 mm 28N/mm ²	Solid brick 19N/mm ²	Beton C12/15	Beton ≥ C16/20
Minimum thickness of material h _{min}	100	100	108	108	100	100
Minimum spacing, one anchor S _{min}	250	250	250	250	70	50
Minimum edge distance, one anchor C _{min}	100	100	110	110	70	50
Minimum spacing, anchor group perpendicular to edge S _{1min}	400	400	440	440	70	50
Minimum spacing, anchor group parallel to edge S _{2min}	200	200	220	220	70	50
Minimum edge distance, anchor group C _{min}	100	100	110	110	70	50



MFA with flange head



TYPE	d_0 [mm] 	h_1 [mm]	t_{fix} [mm]	ART. NR.		EAN 13
------	---	------------	----------------	----------	---	--------

ZINC-PLATED

10 x 70	10	80	5	584070	50	5708620059938
10 x 85	10	95	20	584085	50	5708620059945
10 x 100	10	110	35	584100	50	5708620059952
10 x 115	10	125	50	584115	50	5708620059969
10 x 135	10	145	70			
10 x 160	10	170	95			

HOT DIP GALVANIZED

10 x 70	10	80	5	585070	50	5708620059976
10 x 85	10	95	20	585085	50	5708620059983
10 x 100	10	110	35			
10 x 115	10	125	50			
10 x 135	10	145	70			
10 x 160	10	170	95			

Super Nylon Plug

Super nylon plug
 Super Nylandübel
 Cheville Super Nylon
 Super Nylon Pløk

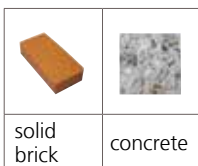

Type	Load capacities			
	Concrete 25 N/mm ²		Solid brick 15 N/mm ²	
	Tension load N _{rec}	Shear load V _{rec}	Tension load N _{rec}	Shear load V _{rec}
4 x 20	(0,3)	(0,1)	(0,1)	(0,1)
5 x 25	1,2 (0,3)	0,3	0,5 (0,3)	0,3
6 x 30	1,3 (0,6)	0,6	0,9 (0,6)	0,4
8 x 40	1,6 (1,0)	1,2	1,3 (1,0)	1,2
10 x 50	3,2	2,4	1,7	1,4
12 x 60	4,0	3,6	2,2	2,0
14 x 70	5,0	4,7	-	-
16 x 80	5,8	5,8	-	-
20 x 90	8,0	6,5	-	-

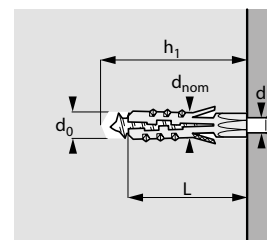

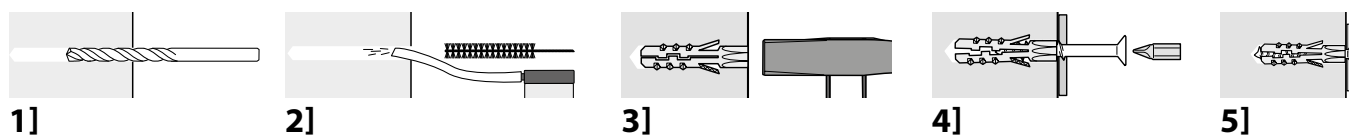
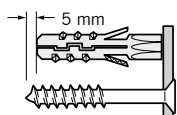

Conditions on load capacity: See page I, ref# 5



Super Nylon Plug



TYPE		d_0 [mm]	h_1 [mm]	ART. NR.		h ₁ [mm]	EAN 13
4 x 20	2,0 - 3,0	4	30	260420	100		5708620026077
5 x 25	2,5 - 4,0	5	35	260525	100		5708620026015
6 x 30	3,5 - 5,0	6	40	260630	100		5708620026022
8 x 40	4,5 - 6,0	8	50	260840	100		5708620026046
10 x 50	6,0 - 8,0	10	60	261050	50		5708620026053
12 x 60	8,0 - 10,0	12	70	261260	25		5708620026060
14 x 70	10,0 - 12,0	14	80	261470	20		5708620026145
16 x 80	12,0	16	90	261680	15		5708620026152
20 x 90	14,0 - 16,0	20	100	262090	10		5708620026183

MEGA PACK

5 x 25	2,5 - 4,0	5	35	240525	200		5708620026299
6 x 30	3,5 - 5,0	6	40	240630	200		5708620026305
8 x 40	4,5 - 6,0	8	50	240840	300		5708620026312
10 x 50	6,0 - 8,0	10	60	241050	100		5708620026329
12 x 60	8,0 - 10,0	12	70	241260	75		5708620026336
14 x 70	10,0 - 12,0	14	80	241470	50		5708620026985

XL MEGA PACK

4 x 20	2,0 - 3,0	4	30	240420 XL	6.000		5708620027159
5 x 25	2,5 - 4,0	5	35	240525 XL	3.000		5708620026473
6 x 30	3,5 - 5,0	6	40	240630 XL	3.000		5708620026480
8 x 40	4,5 - 6,0	8	50	240840 XL	1.500		5708620026497
10 x 50	6,0 - 8,0	10	60	241050 XL	800		5708620026503
12 x 60	8,0 - 10,0	12	70	241260 XL	500		5708620026510
14 x 70	10,0 - 12,0	14	80	241470 XL	500		5708620026886

BULK CARTON

5 x 25	2,5 - 4,0	5	35	200525	35.000		5708620027807
6 x 30	3,5 - 5,0	5	40	200630	20.000		5708620027814
8 x 40	4,5 - 6,0	8	50	200840	9.000		5708620027821
10 x 50	6,0 - 8,0	10	60	201050	4.500		5708620027838
12 x 60	8,0 - 10,0	12	70	201260	2.700		5708620027845
14 x 70	10,0 - 12,0	14	80	201470	1.800		5708620026879

Nail Anchor

Slagplug
Nageldübel
Cheville à frapper
Sømpløk

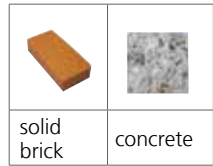

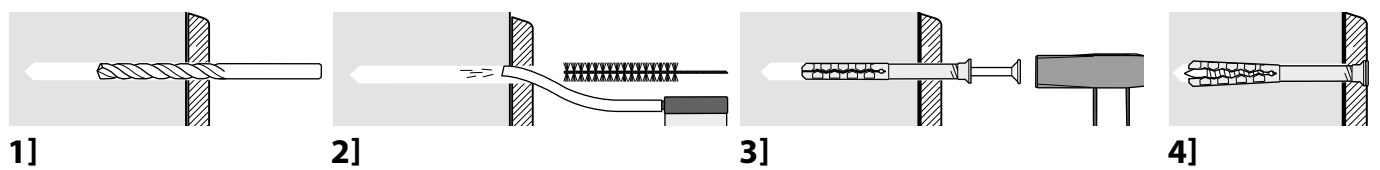
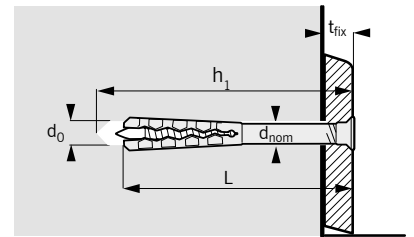

Type	Load capacities			
	Beton 25 N/mm ²		Solid brick 15 N/mm ²	
DIAMETER	Recommended Tension load N _{Rd}	Recommended Shear load V _{Rd}	Recommended Tension load N _{Rd}	Recommended Shear load V _{Rd}
5 x	0,30	0,35	0,20	0,35
6 x	0,45	0,55	0,30	0,55
8 x	0,55	0,50	0,45	0,50
10 x	0,75	0,50	0,55	0,50

Conditions on load capacity: See page I, ref# 1



Nail Anchor with countersunk collar, zinc plated nail



TYPE	d_0 [mm] 	h_1 [mm]	t_{fix} [mm]	ART. NR.		EAN 13
5 x 50	5	60	25	560505	100	5708620056012
6 x 35	6	45	5	560604	100	5708620056159
6 x 60	6	70	30	560606	50	5708620056029
8 x 80	8	90	40	560808	25	5708620056173
8 x 100	8	110	60	560810	25	5708620056180
MEGA PACK						
5 x 30	5	40	5	540503	250	5708620057101
5 x 40	5	50	15	540504	250	5708620057095
5 x 50	5	60	25	540505	250	5708620057118
6 x 30	6	35	5	540603	250	
6 x 35	6	45	5	540604	250	5708620057125
6 x 50	6	60	20	540605	200	5708620057729
6 x 60	6	70	30	540606	200	5708620057132
6 x 80	6	90	50	540607	200	5708620057149
8 x 60	8	70	20	540806	100	5708620057224
8 x 80	8	90	40	540808	100	5708620057156
8 x 100	8	110	60	540810	100	5708620057163
8 x 120	8	130	80	540812	100	5708620057170
8 x 140	8	150	100	540814	100	5708620057736
10 x 80	10	90	30	561008	50	5708620057804
10 x 100	10	110	50	561010	50	5708620057811
10 x 120	10	130	70	561012	50	5708620057828
10 x 140	10	150	90	561014	50	5708620057835
10 x 160	10	170	110	561016	50	5708620057842
BULK CARTON						
5 x 30	5	40	5	500503	5.000	5708620050010
5 x 50	5	60	25	500505	2.500	5708620050027
6 x 60	6	70	30	500606	1.200	5708620050034
6 x 80	6	90	50	500607	1.000	5708620050041
8 x 80	8	90	40	500808	600	5708620050058

Nail Anchor with cylindrical collar, zinc plated nail



TYPE	d_0 [mm]	h_1 [mm]	t_{fix} [mm]	ART. NR.		EAN 13
5 x 25	5	30	5	5905025	200	
5 x 30	5	40	5	5905030	200	5708620050065
5 x 35	5	40	15	5905035	200	
5 x 40	5	45	20	5905040	200	
5 x 50	5	60	25	5905050	200	5708620050072
6 x 25	6	30	0	5906025	200	
6 x 30	6	35	5	5906030	200	
6 x 35	6	45	5	5906035	200	5708620050089
6 x 40	6	50	10	5906040	200	
6 x 45	6	55		5906045	200	5708620050096
6 x 50	6	55	25	5906050	200	
6 x 60	6	70	30	5906060	200	5708620050102
6 x 80	6	90	50	5906080	200	5708620050119
8 x 50	8	55	10	5908050	100	
8 x 60	8	70	20	5908060	100	5708620050126
8 x 80	8	90	40	5908080	100	5708620050133
8 x 100	8	110	60	5908100	100	5708620050140
8 x 120	8	125	80	5908120	100	
8 x 140	8	145	100	5908140	100	

Nail Anchor with countersunk collar, INOX A2 (304)



TYPE	d_0 [mm]	h_1 [mm]	t_{fix} [mm]	ART. NR.		EAN 13
5 x 30	5	40	5	560503 R	100	5708620057606
5 x 50	5	60	25	560505 R	100	5708620057613
6 x 35	6	45	5	560604 R	100	5708620057620
6 x 50	6	60	20	560605 R	50	5708620058108
6 x 60	6	70	30	560606 R	50	5708620057644
6 x 70	6	80		560607 R	50	5708620057651
8 x 60	8	70	20	560806 R	25	5708620057668
8 x 80	8	90	40	560808 R	25	5708620057675
8 x 100	8	110	60	560810 R	25	5708620057682
8 x 120	8	130	80	560812 R	25	5708620057699
8 x 140	8	150	100	560814 R	25	5708620057705



Multi Plug

Multi plug
Multidübel
Cheville Multi
Multi Pløk



				
solid brick	hollow brick	concrete	perforated sand-lime stone	natural stone

Type	Load capacities		
	Concrete C 20/25	Solid Brick	Hollow Brick
DIAMETER	Recommended Tension Load N_{rec} (kN)	Recommended Tension Load N_{rec} (kN)	Recommended Tension Load N_{rec} (kN)
5 x 25	0,32	0,27	0,14
6 x 30	0,50	0,27	0,14
8 x 40	0,54	0,36	0,27
10 x 50	1,43	0,71	0,54
12 x 60	2,14	0,82	0,59
14 x 70	4,29	0,91	0,64

Conditions on load capacity: See page I, ref# 5

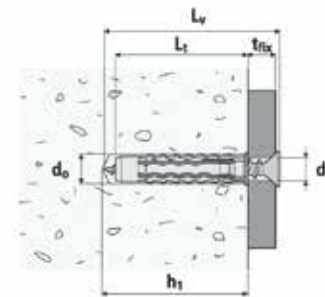

FIXINGS FOR CONCRETE AND BRICK

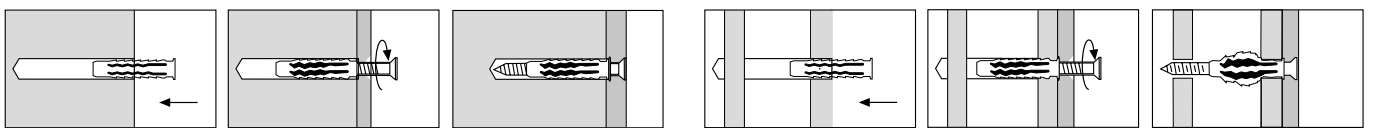

1] 2] 3] 4] 5] 6]







TYPE	d_0 [mm]	L [mm]	t_{fix} [mm]	ART. NR.		EAN 13
Multi plug 6	6	30		E1051	200	
Multi plug 8	8	40		E1052	100	
Multi plug 10	10	50		E1053	50	
Multi plug 12	12	60		E1054	50	
Multi plug 14	14	70		E1055	25	

Universal Plug

Universele plug
 Universaldübel
 Cheville universelle
 Universal Pløk



				
solid brick	hollow brick	concrete	perforated sand-lime stone	natural stone

Type	Load capacities		
	Concrete C 20/25	Solid brick	Hollow brick
DIAMETER	Recommended tension load N_{rec} (kN)	Recommended tension load N_{rec} (kN)	Recommended tension load N_{rec} (kN)
6 x 32	0,22	0,22	0,20
8 x 50	0,45	0,45	0,25
10 x 60	0,70	0,70	0,40

Conditions on load capacity: See page I, ref# 5

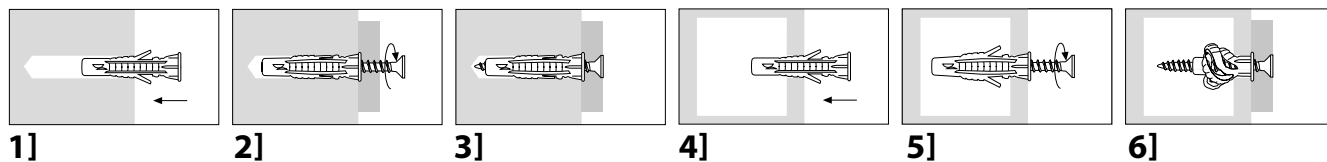
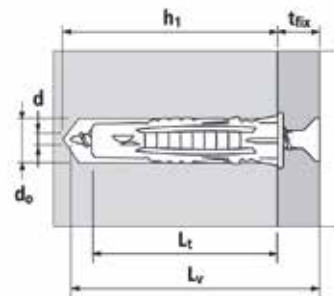

TYPE	d_0 [mm]	L [mm]	ART. NR.	EAN 13
Universal plug 6	6	35	E1065	200
Universal plug 8	8	50	E1066	100
Universal plug 10	10	60	E1067	50

Metal Frame Fixing

Metalen kozijnplug
 Metall-Rahmendübel
 Cheville métallique pour la pose de fenêtre
 Metal Karmpløk



Type	Load capacities		
	Concrete C 20/25	Solid Brick	Hollow Brick
DIAMETER	Recommended Tension Load N_{rec} (kN)	Recommended Tension Load N_{rec} (kN)	Recommended Tension Load N_{rec} (kN)
8 mm	0,64	0,56	0,16
10 mm	1,04	0,96	0,24

Conditions on load capacity: See page I, ref# 1

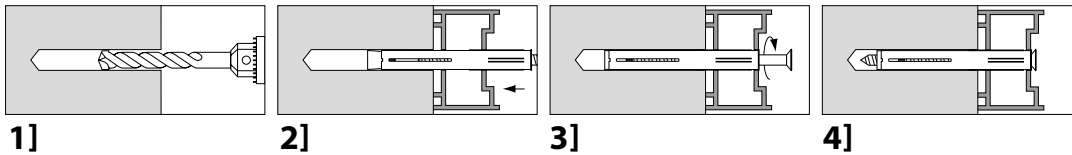
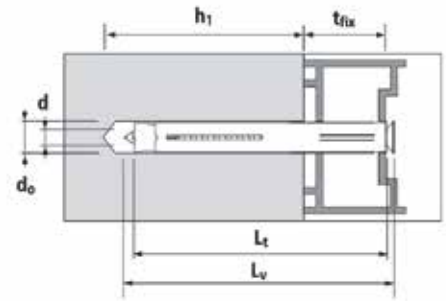

TYPE	d_0 [mm]	h_1 [mm]	t_{fix} [mm]	ART. NR.		EAN 13
8 x 72K	8	40	42	E32078	100	
8 x 92K	8	40	62	E32079	100	
8 x 112K	8	40	82	E32080	100	
8 x 132K	8	40	102	E32081	100	
10 x 52	10	40	22	E32095	100	
10 x 72	10	40	42	E32096	100	
10 x 92	10	40	62	E32097	100	
10 x 112	10	40	82	E32098	100	
10 x 132	10	40	102	E32099	100	
10 x 152	10	40	122	E32100	100	
10 x 182	10	40	152	E32101	100	
10 x 202	10	40	172	E32102	100	

Concrete Screw

Kozijnschroef
 Fensterrahmenschraube
 Vis pour béton
 Betonskrue

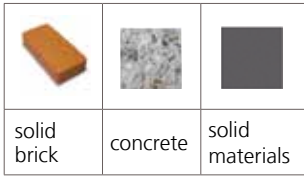
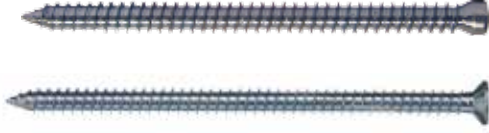

FIXINGS FOR CONCRETE AND BRICK

Type	h _{nom} [mm] (minimum)	Load capacities ¹⁾	
		Design resistance Tension load N _{Rd}	Design resistance Shear load V _{Rd}
Expandet Concrete Screw			
Concrete (20 N/mm ²)	30	2,10	1,80
Solid brick (15N/mm ²)	40	1,04	0,85
Lightweight Aggregate Concrete (LAC) 6/ 1350	70	1,1	1,0
Lightweight Aggregate Concrete (LAC)10/ 1550	70	1,7	1,3
Aerated concrete (PP4) *	80	0,30	0,28
Aerated concrete (PP2) *	60	0,22	0,08
Solid Sand-Lime Brick/Block	40	1,00	0,85

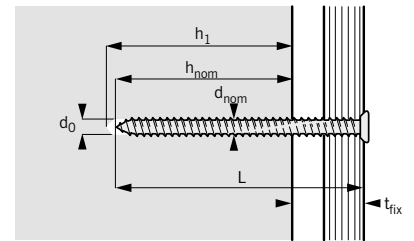

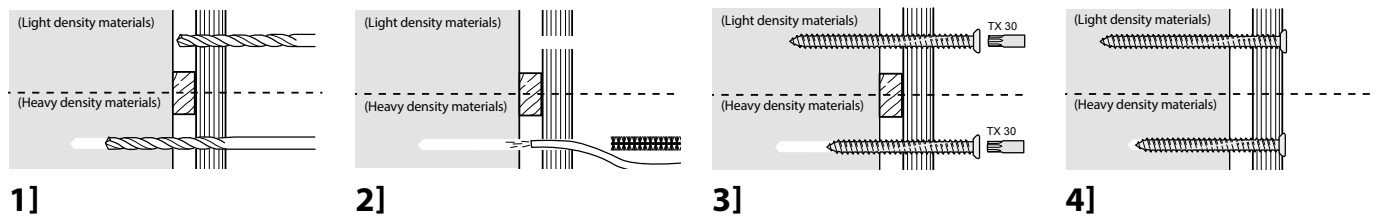

Conditions on load capacity: See page I, ref# 1

*When installing in aerated concrete use low torque settings and machines with limited power as the density of the aerated concrete can cause the screw to overturn.





Concrete Screw without head, zinc plated



TYPE	d ₀ [mm]		h _{nom} [mm]	ART. NR.		EAN 13
7,5 x 42	6 - 6,5	8,5	30 - 80	975042	100	5708620097640
7,5 x 52	6 - 6,5	8,5	30 - 80	975052	100	5708620200439
7,5 x 62	6 - 6,5	8,5	30 - 80	975062	100	5708620098067
7,5 x 72	6 - 6,5	8,5	30 - 80	975072	100	5708620097756
7,5 x 92	6 - 6,5	8,5	30 - 80	975092	100	5708620097718
7,5 x 112	6 - 6,5	8,5	30 - 80	975112	100	5708620097725
7,5 x 132	6 - 6,5	8,5	30 - 80	975132	100	5708620097732
7,5 x 152	6 - 6,5	8,5	30 - 80	975152	100	5708620098197
7,5 x 182	6 - 6,5	8,5	30 - 80	975182	100	5708620097763
7,5 x 212	6 - 6,5	8,5	30 - 80	975212	100	5708620200675

Concrete Screw with head, zinc plated



TYPE	d ₀ [mm]		h _{nom} [mm]	ART. NR.		EAN 13
7,5 x 42	6 - 6,5	12,0	30 - 80	975042H	100	5708620097657
7,5 x 52	6 - 6,5	12,0	30 - 80	975052H	100	5708620200446
7,5 x 62	6 - 6,5	12,0	30 - 80	975062H	100	5708620098074
7,5 x 72	6 - 6,5	12,0	30 - 80	975072H	100	5708620097664
7,5 x 92	6 - 6,5	12,0	30 - 80	975092H	100	5708620097671
7,5 x 112	6 - 6,5	12,0	30 - 80	975112H	100	5708620097688
7,5 x 132	6 - 6,5	12,0	30 - 80	975132H	100	5708620097695
7,5 x 152	6 - 6,5	12,0	30 - 80	975152H	100	5708620097701
7,5 x 182	6 - 6,5	12,0	30 - 80	975182H	100	5708620098203
7,5 x 212	6 - 6,5	12,0	30 - 80	975212H	100	5708620097633



Concrete Screw with pan head, zinc plated



TYPE	d ₀ [mm]	h _{nom} [mm]	ART. NR.		EAN 13
7,5 x 42	6 - 6,5	30 - 80	975042P	100	5708620099088



Concrete Screw Outdoor without head



TYPE	d ₀ [mm]		h _{nom} [mm]	ART. NR.		EAN 13
7,5 x 72	6 - 6,5	8,5	30 - 80	975072R	100	5708620200453
7,5 x 92	6 - 6,5	8,5	30 - 80	975092R	100	5708620200460
7,5 x 112	6 - 6,5	8,5	30 - 80	975112R	100	5708620200477
7,5 x 132	6 - 6,5	8,5	30 - 80	975132R	100	5708620200736
7,5 x 152	6 - 6,5	8,5	30 - 80	975152R	100	5708620207926

Concrete Screw Outdoor with head



TYPE	d ₀ [mm]		h _{nom} [mm]	ART. NR.		EAN 13
7,5 x 72	6 - 6,5	12,0	30 - 80	975072HR	100	5708620200743
7,5 x 92	6 - 6,5	12,0	30 - 80	975092HR	100	5708620200750
7,5 x 112	6 - 6,5	12,0	30 - 80	975112HR	100	5708620200767
7,5 x 132	6 - 6,5	12,0	30 - 80	975132HR	100	5708620200774
7,5 x 152	6 - 6,5	12,0	30 - 80	975152HR	100	5708620207933

Frame screw, Inox A2 (304)

Kozijnschroef, RVS A2 (304)

Fensterrahmenschraube, nichtrostender Stahl, A2 (304)

Vis pour châssis, Inox A2 (304)

Betonskrue Udendørs med hoved

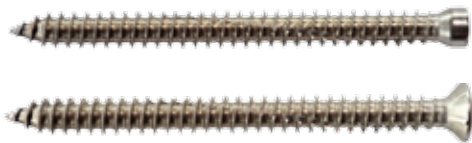

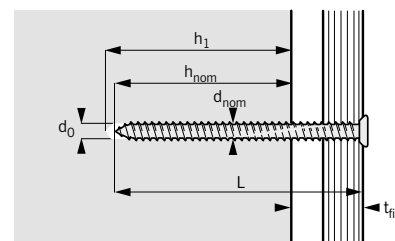

solid brick

Type	h_{nom} [mm] (minimum)	Load capacities	
		Design Load, tension N_{Rd}	Design Load, shear V_{Rd}
Solid brick (15N/mm ²)	40	1,04	0,85
Lightweight Aggregate Concrete (LAC) 6/1350	70	1,1	1,0
Lightweight Aggregate Concrete (LAC)10/1550	70	1,7	1,3
Aerated concrete (PP4)	80	0,30	0,28
Aerated concrete (PP2)	60	0,22	0,08
Solid Sand-Lime Brick/Block	40	1,00	0,85

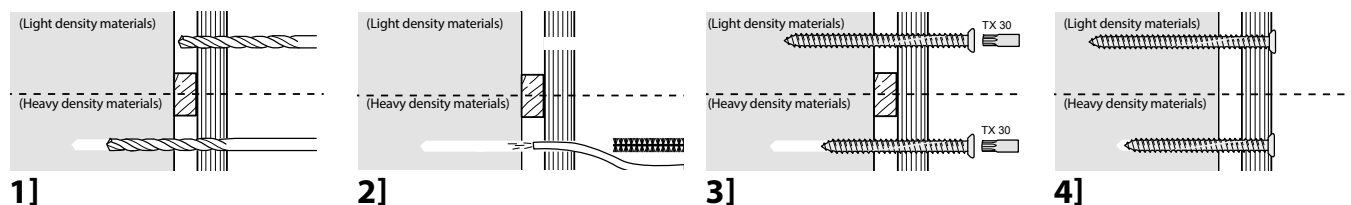

Conditions on load capacity: See page I, ref# 1



TYPE		d_0 [mm]		h_{nom} [mm]	ART. NR.		EAN 13
7,5 x 72	without head	6	8,5	40 - 80	975072A2	100	5708620209807
7,5 x 92	without head	6	8,5	40 - 80	975092A2	100	5708620209814
7,5 x 112	without head	6	8,5	40 - 80	975112A2	100	5708620209821
7,5 x 132	without head	6	8,5	40 - 80	975132A2	100	5708620209838
7,5 x 72	with head	6	12,0	40 - 80	975072HA2	100	5708620209845
7,5 x 92	with head	6	12,0	40 - 80	975092HA2	100	5708620209852
7,5 x 112	with head	6	12,0	40 - 80	975112HA2	100	5708620209869
7,5 x 132	with head	6	12,0	40 - 80	975132HA2	100	5708620209876

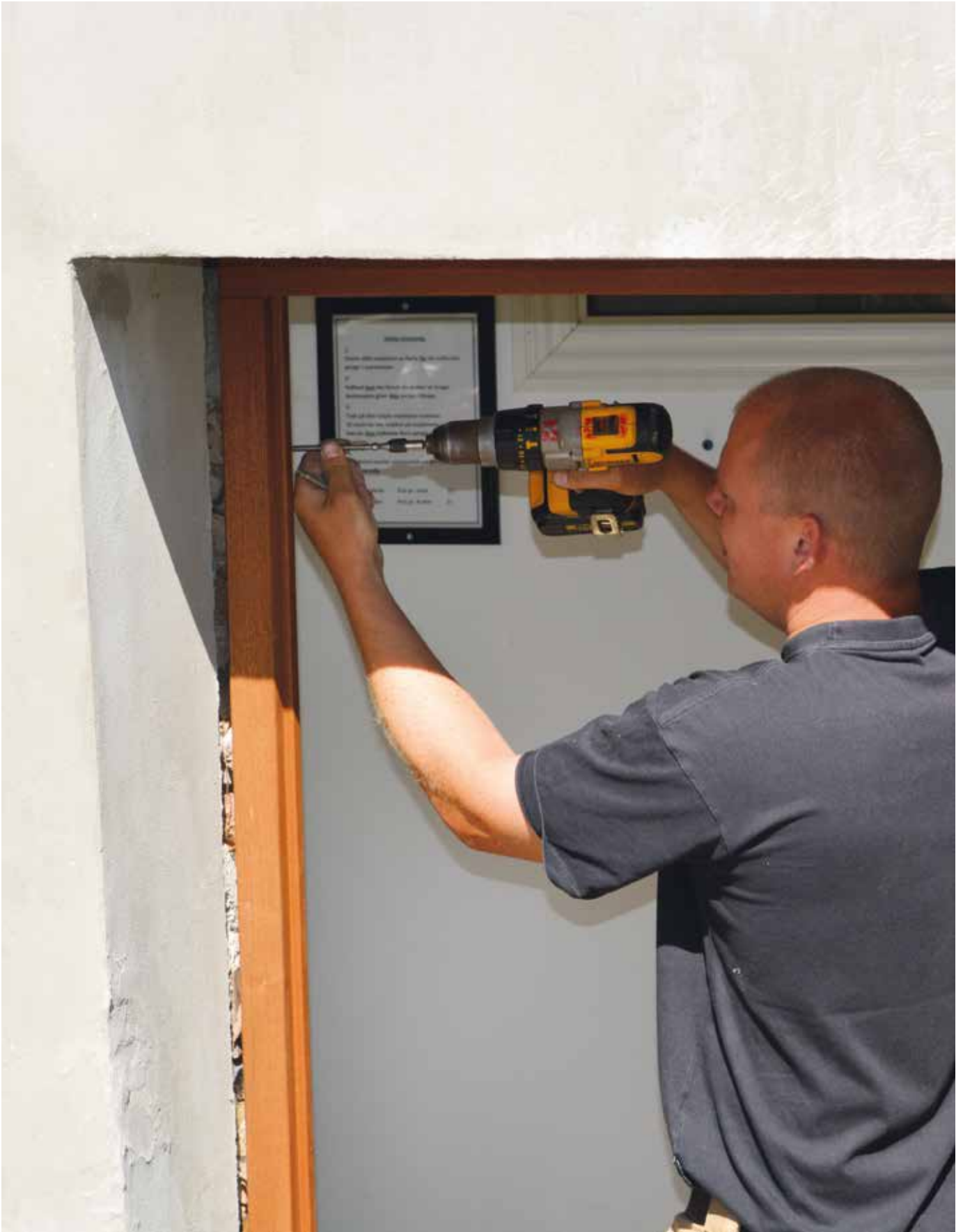

FIXINGS FOR CONCRETE AND BRICK

Wallplug

Muurplug
Wanddübel
Cheville
Murpløk

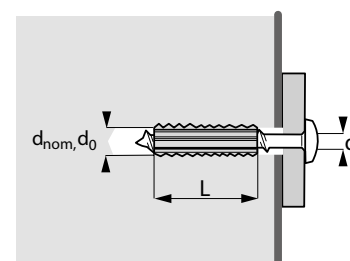
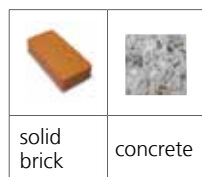
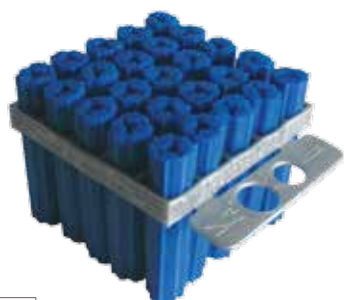

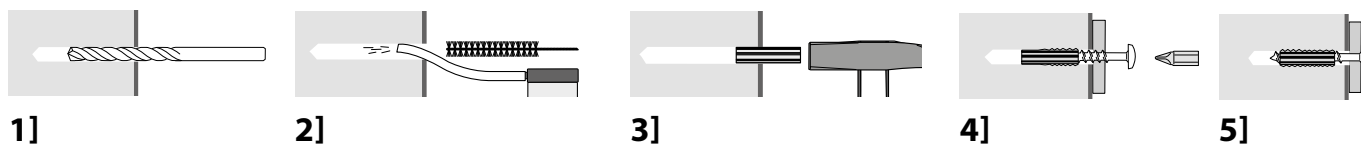
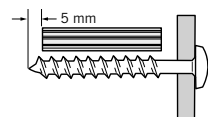

Type		Load capacities
DIMENSION		N_{rec}
		Recommended tension load kN
White	5 x 25	0,65
White	5 x 35	0,85
Red	6 x 25	0,75
Red	6 x 35	0,90
Green	7 x 25	0,85
Green	7 x 32	1,05
Green	7 x 35	1,20
Green	7 x 50	1,75
Blue	8 x 25	1,00
Blue	8 x 35	1,40
Blue	8 x 50	1,85
Orange	10 x 35	1,25
Orange	10 x 50	1,80
Orange	10 x 60	2,00
Grey	12 x 50	1,80
Grey	12 x 60	4,60
Grey	12 x 75	5,25
Black	14 x 60	4,70
Black	14 x 90	5,25

Conditions on load capacity: See page I, ref# 4







Wallplug

TYPE			d_0 [mm] 	ART. NR.		EAN 13
White	5 x 25	3,0 - 4,0	5	120525	20 / 500	5708620016023
White	5 x 35	3,0 - 4,0	5	120535	20 / 500	5708620016047
Red	6 x 25	3,5 - 5,0	6	120625	20 / 500	5708620016054
Red	6 x 35	3,5 - 5,0	6	120635	20 / 500	5708620016078
Green	7 x 25	4,5 - 5,5	7	120725	20 / 500	5708620016092
Green	7 x 30	4,5 - 5,5	7	120730	20 / 500	5708620016108
Green	7 x 35	4,5 - 5,5	7	120735	20 / 500	5708620016115
Green	7 x 50	4,5 - 5,5	7	120750	10 / 250	5708620016122
Blue	8 x 25	5,0 - 6,0	8	120825	20 / 500	5708620016139
Blue	8 x 35	5,0 - 6,0	8	120835	20 / 500	5708620016153
Blue	8 x 50	5,0 - 6,0	8	120850	10 / 250	5708620016160
Orange	10 x 35	8,0	10	121035	4 / 100	5708620016184
Orange	10 x 50	8,0	10	121050	4 / 100	5708620016191
Orange	10 x 60	8,0	10	121060EX	4 / 100	5708620016207
Grey	12 x 50	10,0	12	121250	4 / 100	5708620016221
Grey	12 x 60	10,0	12	121260	4 / 100	5708620016238
Grey	12 x 75	10,0	12	121275	4 / 100	5708620016245
Black	14 x 60	12,0	14	121460	4 / 48	5708620016252
Black	14 x 90	12,0	14	121490	4 / 48	5708620016269



Wallplug

TYPE			d_0 [mm] 	ART. NR.		EAN 13
White	5 x 25	3,0 - 4,0	5	140525	20 / 500	5708620016504
White	5 x 35	3,0 - 4,0	5	140535	20 / 500	5708620016597
Red	6 x 25	3,5 - 5,0	6	140625	20 / 500	5708620016511
Red	6 x 35	3,5 - 5,0	6	140635	20 / 500	5708620016528
Green	7 x 25	4,5 - 5,5	7	140725	20 / 500	5708620016535
Green	7 x 35	4,5 - 5,5	7	140735	20 / 500	5708620016542
Green	7 x 50	4,5 - 5,5	7	140750	10 / 250	5708620016559
Blue	8 x 35	5,0 - 6,0	8	140835	20 / 500	5708620016566
Blue	8 x 50	5,0 - 6,0	8	140850	10 / 250	5708620016573

Express Nail

Spanhulzen
Spannhülsen
Clous Express
Fjederstålsøm

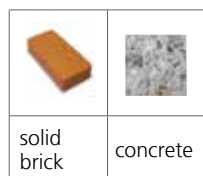

Type	Load capacities			
	Concrete 25 N/mm ²		Solid brick 15 N/mm ²	
	Tension load N _{rec}	Shear load V _{rec}	Tension load N _{rec}	Shear load V _{rec}
5 x 26	0,30	0,40	-	-
5 x 50	0,30	0,40	-	-
6 x 30	0,70	1,00	0,50	0,80
6 x 60	0,70	1,00	0,50	0,80
6 x 80	0,70	1,00	0,50	0,80
6 x 100	0,70	1,00	0,50	0,80
8 x 70	1,00	1,30	0,80	1,10
8 x 90	1,00	1,30	0,80	1,10
8 x 110	1,00	1,30	0,80	1,10
8 x 130	1,00	1,30	0,80	1,10

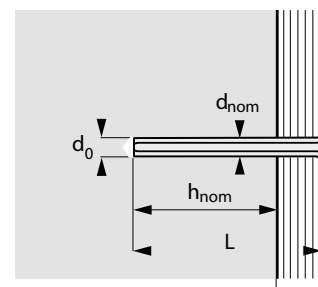

Conditions on load capacity: See page I, ref# 1

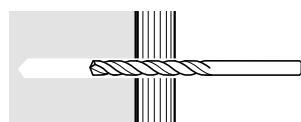

1]



2]



3]

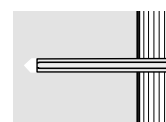

4]



TYPE	d ₀ [mm]	h _{nom} [mm]	t _{fix} [mm]	ART. NR.		EAN 13
5 x 26	5	20	6	965026	100	5708620096575
5 x 50	5	20	30	965050	100	5708620097220
6 x 30	6	25	3	966030	100	5708620096506
6 x 40	6	25	8	966040	100	
6 x 50	6	30	20	966050	100	
6 x 60	6	30	30	966060	100	5708620096513
6 x 80	6	30	50	966080	100	5708620096520
6 x 100	6	30	70	966100	100	5708620096582
8 x 70	8	40	30	968070	100	5708620096537
8 x 90	8	40	50	968090	100	5708620096544
8 x 110	8	40	70	968110	100	5708620096551
8 x 130	8	40	90	968130	100	5708620096568
8 x 150	8	40	110	968150	100	
8 x 180	8	40	140	968180	100	

Alum-Nail-in Anchor

Alum-Nagelplug
Alum-Nageldübel
Alum-D'Ancrage
Aluslagnitte

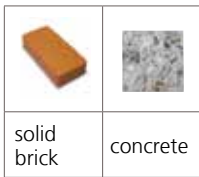

Type	Load capacities			
	Concrete 25 N/mm ²		Solid brick 15 N/mm ²	
	Tension load N _{rec}	Shear load V _{rec}	Tension load N _{rec}	Shear load V _{rec}
4,8 x 16	0,35	0,35	0,35	0,35
4,8 x 20	0,35	0,35	0,35	0,35
4,8 x 26	0,35	0,35	0,35	0,35
4,8 x 30	0,35	0,35	0,35	0,35
4,8 x 35	0,35	0,35	0,35	0,35
4,8 x 40	0,35	0,35	0,35	0,35
4,8 x 50	0,35	0,35	0,35	0,35

Conditions on load capacity: See page I, ref# 1

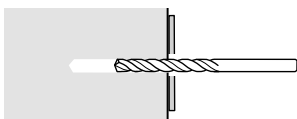
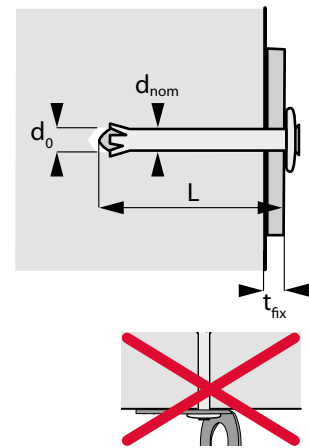

1]

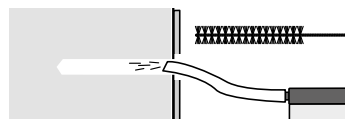

2]

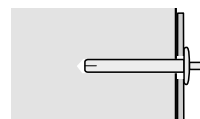

3]

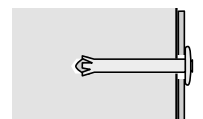

4]

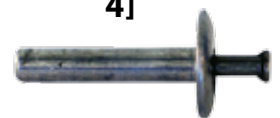





TYPE	t _{fix} [mm]	d ₀ [mm]
4,8 x 16	1	5
4,8 x 20	5	5
4,8 x 26	11	5
4,8 x 30	15	5
4,8 x 35	20	5
4,8 x 40	25	5
4,8 x 50	35	5
6,0 x 40	25	6
6,0 x 55	40	6

ART. NR.		EAN 13
964816	100	5708620096605
964820	100	5708620096612
964826	100	5708620096636
964830	100	5708620096643
964835	100	5708620096650
964840	100	5708620096667
964850	100	5708620096674
230168	100	
230169	100	

Brass Anchor

Messing spreidplug
 Messingdübel
 Cheville en laiton
 Messinganker



			
solid brick	concrete	sand lime brick	wood

Type	Load capacities	
	N_{Rd} Design resistance, tension kN	V_{Rd} Design resistance, shear kN
4 x 16	0,30	0,30
5 x 20	0,40	0,40
6 x 24	0,80	0,80
8 x 30	1,50	1,50
10 x 34	2,10	2,10
12 x 40	3,00	3,00
16 x 40	4,00	4,00

Conditions on load capacity: See page I, ref# 4

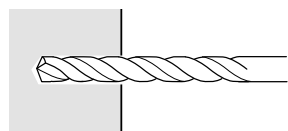

1]

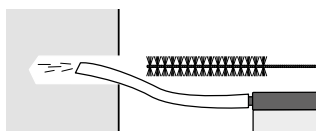

2]

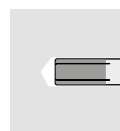

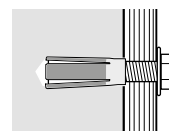

3]

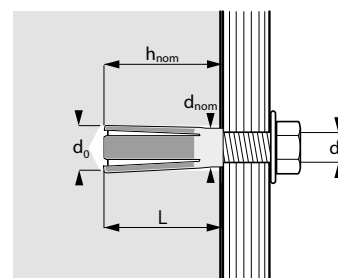

4]







TYPE	d_0 [mm] 	h_{nom} [mm]	L [mm]
4 x 16	5	18	16
5 x 20	6	22	20
6 x 24	8	27	24
8 x 30	10	35	30
10 x 34	12	36	34
12 x 40	16	45	40
16 x 40	20	49	44

ART. NR.		EAN 13
973004	100	5708620096735
973005	100	5708620096742
973006	100	5708620096759
973008	100	5708620096766
973010	100	5708620096773
973012	50	5708620096780
973016	25	5708620096797

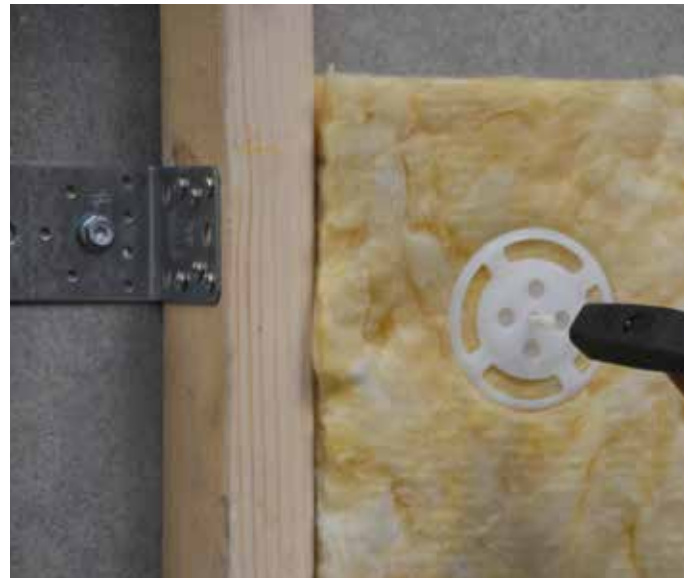
Isoplug with expansion

Isolatie plug, met expansie
 Dämmstoffspreizdübel
 Cheville d'isolation à expansion
 Isopløk med ekspansjon



			
solid brick	concrete	aerated concrete	sand lime brick

Type	Load capacities		
	N _{rec}		
	Recommended Tension load		
DIAMETER	Concrete kN	Solid brick kN	Sand lime brick kN
10 x 70	0,22	0,17	0,16
10 x 90	0,22	0,17	0,16
10 x 110	0,22	0,17	0,16
10 x 130	0,22	0,17	0,16
10 x 150	0,22	0,17	0,16
10 x 180	0,22	0,17	0,16

Conditions on load capacity: See page I, ref# 1

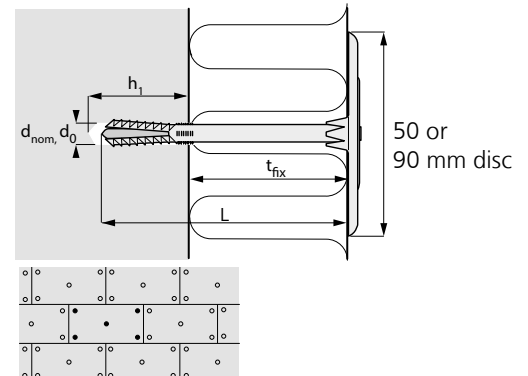

Correct use and positioning of Isoplug

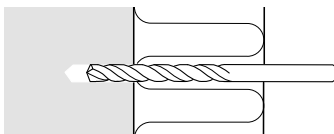

1]

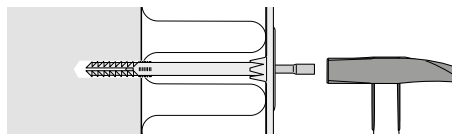

2]

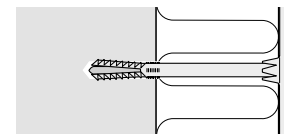

3]



TYPE	d ₀ [mm]	h ₁ [mm]	t _{fx} [mm]	ART. NR.		EAN 13
------	---------------------	---------------------	----------------------	----------	---	--------

WITH 90 MM DISC

10 x 70	10	40	30 - 40	861070-90	250	5708620100791
10 x 90	10	40	50 - 60	861090-90	250	5708620100807
10 x 110	10	40	70 - 80	861110-90	250	5708620100579
10 x 130	10	40	90 - 100	861130-90	200	5708620100586
10 x 150	10	40	110 - 120	861150-90	150	5708620100593
10 x 180	10	40	130 - 150	861180-90	150	5708620100609





WITH 50 MM DISC

10 x 70	10	40	30 - 40	861070-50	250	5708620100777
10 x 90	10	40	50 - 60	861090-50	250	5708620100784
10 x 110	10	40	70 - 80	861110-50	250	5708620100616
10 x 130	10	40	90 - 100	861130-50	250	5708620100623
10 x 150	10	40	110 - 120	861150-50	250	5708620100630
10 x 180	10	40	130 - 150	861180-50	250	5708620100647

Isoplug

Isolatie plug
Dämmstoffdübel
Cheville d'isolation
Isopløk Plast



			
solid brick	concrete	aerated concrete	sand lime brick

Type	Load capacities		
	N _{Rd}		
	Design Tension load		
DIAMETER	Concrete kN	Solid brick kN	Sand lime brick kN
8 x 80	0,18	0,15	0,14
8 x 100	0,18	0,15	0,14
8 x 120	0,18	0,15	0,14
8 x 140	0,18	0,15	0,14
8 x 160	0,18	0,15	0,14
8 x 180	0,18	0,15	0,14
8 x 200	0,18	0,15	0,14
8 x 220	0,18	0,15	0,14
8 x 240	0,18	0,15	0,14

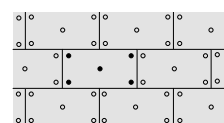
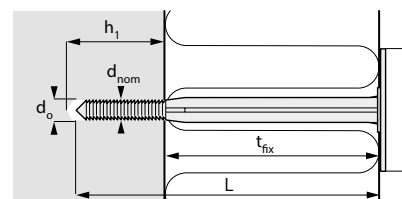

Correct use and positioning of Isoplug

Conditions on load capacity: See page I, ref# 1

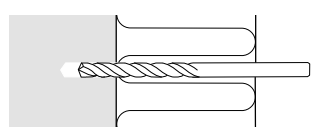

1]

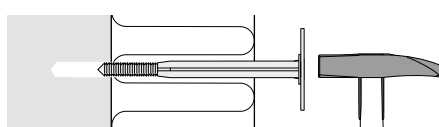

2]

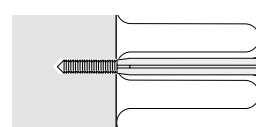

3]



TYPE	d _o [mm]	h ₁ [mm]	t _{fix} [mm]	ART. NR.		EAN 13
8 x 80	8	40	30 - 50	868080	250	5708620101491
8 x 100	8	40	60 - 70	868100	250	5708620101507
8 x 120	8	40	80 - 90	868120	250	5708620101514
8 x 140	8	40	100 - 110	868140	250	5708620101521
8 x 160	8	40	120 - 130	868160	250	5708620101538
8 x 180	8	40	140 - 150	868180	250	5708620101545
8 x 200	8	40	160 - 170	868200	250	5708620101552
8 x 220	8	40	180 - 190	868220	250	5708620101569
8 x 240	8	40	200 - 210	868240	250	5708620101576

Disc for Isoplug

52 mm disc for hard insulation batts.
90 mm disc for soft insulation batts.

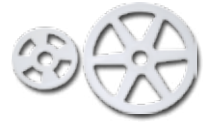

TYPE

52 mm

90 mm

ART. NR.			EAN 13
----------	---	--	--------

868000/52	250		5708620101583
-----------	-----	--	---------------

868000/90	250		5708620101590
-----------	-----	--	---------------

ISO-disc 90 mm

90 mm Expandet Iso-Disc for use with Nail or screw.



TYPE

With 8 mm hole

Fixing with nail / screw

ART. NR.			EAN 13
----------	---	--	--------





868000/908	250		5708620100104
------------	-----	--	---------------

868000/90S	250		5708620100111
------------	-----	--	---------------

Isoplug Metal

Isolatie plug metaal
Dämmstoffdübel, Metall
Cheville d'isolation métallique
Isopløk Metal



			
solid brick	concrete	aerated concrete	sand lime brick

Type	Load capacities				
	DIAMETER	N _{Rd}			
		Design Tension load			
	Concrete kN	Solid brick kN	Hollow brick kN	Aerated concrete(PP4) kN	
8 x 90	0,3	0,3	0,1	0,1	
8 x 110	0,3	0,3	0,1	0,1	
8 x 140	0,3	0,3	0,1	0,1	
8 x 170	0,3	0,3	0,1	0,1	
8 x 200	0,3	0,3	0,1	0,1	
8 x 250	0,3	0,3	0,1	0,1	
8 x 300	0,3	0,3	0,1	0,1	

Design load is valid for a single anchor
Conditions on load capacity: See page I, ref# 1

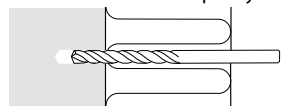

1]

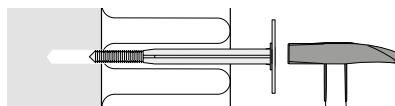

2]

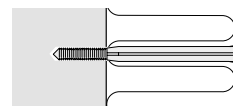

3]

TYPE	d ₀ [mm]	h ₁ [mm]	t _{fix} [mm]
8 x 60	8	35	25
8 x 80	8	50	30
8 x 90	8	40 (50)*	50 (40)*
8 x 110	8	40 (50)*	80 (70)*
8 x 140	8	40 (50)*	110 (100)*
8 x 170	8	40 (50)*	140 (130)*
8 x 200	8	40 (50)*	170 (160)*
8 x 250	8	50 (60)*	200 (190)*
8 x 300	8	50 (60)*	250 (240)*

* Values in () are valid for fixing in hollow brick and Aerated concrete

Iso-disc Metal, 80 mm

TYPE
Ø 80 mm for 868250 og 868300
Ø 80 mm

ART. NR.		EAN 13
868060-35	250	
868080-35	250	
868090-35	250	5708620102221
868110-35	250	5708620102238
868140-35	250	5708620102245
868170-35	250	5708620102252
868200-35	250	5708620102269
868250-35	200	5708620102276
868300-35	200	5708620102306

ART. NR.		EAN 13
868000-8	250	5708620102283
868000-80	250	5708620102214



Long Isoplug

Isolatie plug, lang
 Langer Dämmstoffdübel
 Cheville d'isolation longue
 Lang Isopløk



		
solid brick	concrete	natural stone

Type	Load capacities		
	N _{Rd}		
	Design Tension load		
DIAMETER	Concrete kN	Solid brick kN	Sand lime brick kN
8 x 260	0,18	0,15	0,14
8 x 300	0,18	0,15	0,14
8 x 360	0,18	0,15	0,14
8 x 400	0,18	0,15	0,14

Conditions on load capacity: See page I, ref# 1

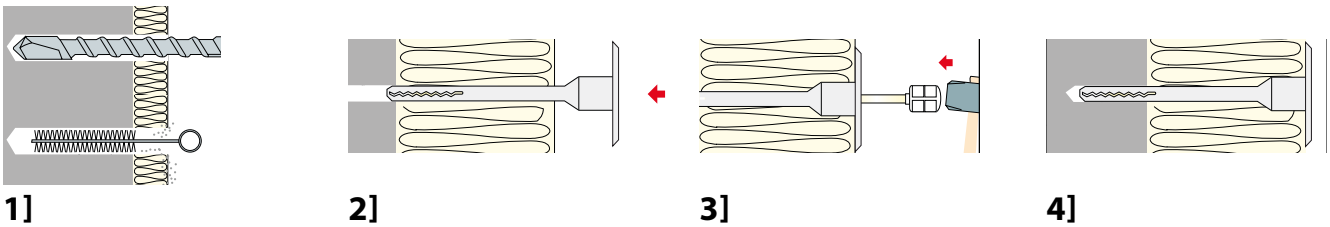

1]

2]

3]

4]



TYPE	d ₀ [mm]	h ₁ [mm]	t _{fix} [mm]	ART. NR.		EAN 13
8 x 260	8	55	105 - 180	868260-60	200	5708620102917
8 x 300	8	55	220 - 250	868300-60	200	5708620102924
8 x 360	8	55	280 - 305	868360-60	200	5708620102931
8 x 400	8	50	320 - 350	868400-60	100	5708620102948

Disc for Long Isoplug

TYPE
100 mm



ART. NR.		EAN 13
868000-100	200	5708620102900

FIXINGS FOR CONCRETE AND BRICK

Expansion Bolt

Keilbout
Bolzenspreizanker
Boulon à expansion
Ekspansionsbolt



Type	DIMENSION	h_{nom} [mm]	Load capacities	
			N_{Rd}	V_{Rd}
			Design resistance Tension kN	Design resistance Shear kN
M6		40	3,3	6,4
M8		40	6,0	9,9
M8		50	6,0	9,9
M10		60	8,0	18,4
M12		80	10,6	26,4
M16		110	11,9	50,2

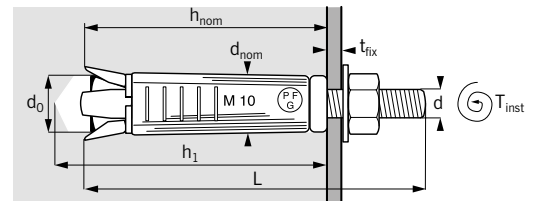

Only use M6 and M8 bolts in solid brick

Conditions on load capacity: See page I, ref# 4

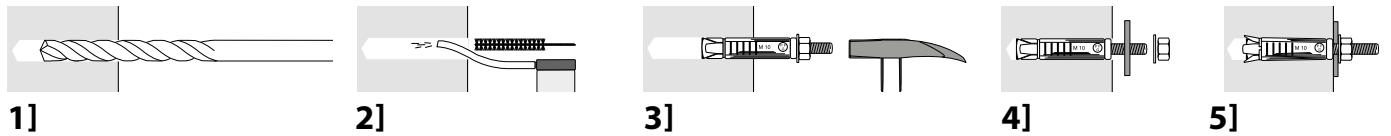

TYPE	h [mm]	d_0 [mm]	h_1 [mm]	t_{fix} [mm]	ART. NR.	Option 8	EAN 13	
6 x 60	•	100	10	55	15	K550AC	50	5708620096056
6 x 75	•	100	10	55	30	K560AC	50	5708620096063
8 x 75	•	100	14	65	20	K600AC	50	5708620096070
8 x 85	•	100	14	55	30	K590AC	50	5708620096360
8 x 100	•	100	14	65	45	K610AC	50	5708620096087
10 x 90		120	16	75	20	K650AC	25	5708620096438
10 x 100		120	16	75	30	K680AC	25	5708620201818
10 x 110		120	16	75	40	K670AC	25	5708620201795
10 x 120		120	16	75	50	K690AC	25	5708620096124
10 x 140		120	16	75	70	K700AC	25	5708620096261
12 x 110		160	20	100	20	K750AC	10	5708620201801
12 x 120		160	20	100	30	K770AC	10	5708620201788
12 x 155		160	20	100	65	K800AC	10	5708620096155
16 x 140	*	200	25	120	25	K870AC	10	5708620096162

ETA, Option 8, CE-marked

- Recommended for use in solid brick
- * Not included in ETA approval



Expansion Shield

Keilhuls
 Innengewindespreizanker
 Boulon à expansion
 Ekspansionshylster



		
solid brick	concrete	natural stone

Type	h _{nom} [mm]	Load capacities with 8.8 steel	
		N _{Rd} Design resistance Tension kN	V _{Rd} Design resistance Shear kN
M6	40	3,3	Shear
M8	50	6,0	kN
M10	60	8,0	18,4
M12	80	10,6	26,4
M16	110	11,9	50,2

Conditions on load capacity: See page I, ref# 4

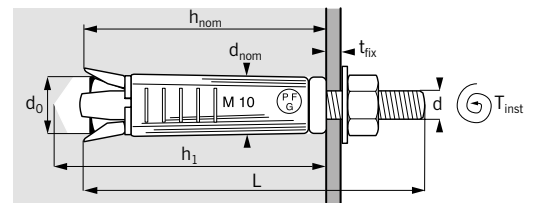

Only use bolt diameter M6 and M8 in solid brick

FIXINGS FOR CONCRETE AND BRICK



1]

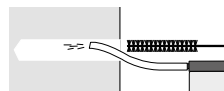

2]

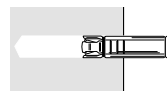

3]



4]

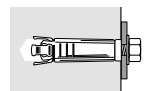

5]



TYPE	h [mm]	d ₀ [mm]	h ₁ [mm]	t _{fix} [mm]
6 x 40	100	10	45	40
8 x 50	100	14	55	50
10 x 60	120	16	65	60
12 x 80	160	20	85	80
16 x 100	200	25	110	100

ART. NR.		EAN 13
HAC240	50	5708620096193
HAC250	50	5708620096209
HAC260	50	5708620096216
HAC270	25	5708620096223
HAC280	10	5708620096230

ETA, Option 8 (with metric screw or threaded rod in 8.8 steel), CE-marked



- Recommended for use in solid brick
- * Not included in ETA approval



Chemical Anchor

Chemisch anker
Verbundanker
Ancrage chimique
Klæbeanker, ampul



		
solid brick	concrete	aerated concrete

Type	Load capacities
DIMENSION	F_{Rd}
	Combined Design resistance kN
M8	4,0
M10	7,0
M12	10,0
M16	15,0
M20	27,0
M24	37,0

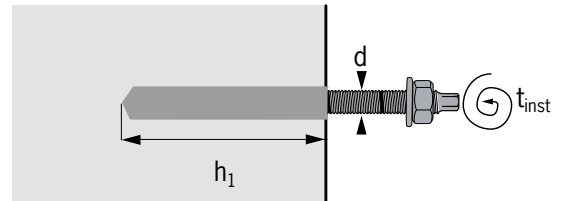

Conditions on load capacity: See page I, ref# 4

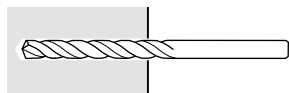

1]

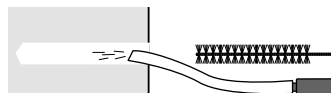

2]



3]



4]



5]



6]



TYPE	h [mm]	d_0 [mm]	h_1 [mm]	ART. NR.		EAN 13
M 8 x 80	130	10	80	900008	10	5708620097503
M 10 x 80	140	12	90	900010	10	5708620097510
M 12 x 95	160	14	110	900012	10	5708620097527
M 16 x 95	175	18	125	900016	10	5708620097534

Iso-Screw

Isolatie schroef plug
 Dämmstoffschraube
 Cheville d'isolation à visser
 Iso-skrue

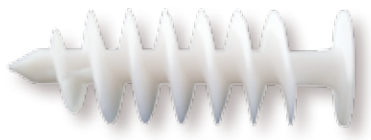



FIXINGS FOR CONCRETE AND BRICK

Type	Load capacities
DIMENSION	F_{Rd}
	Combined Design resistance (kN)
Iso-Screw 50	0,03
Iso-Screw 80	0,05

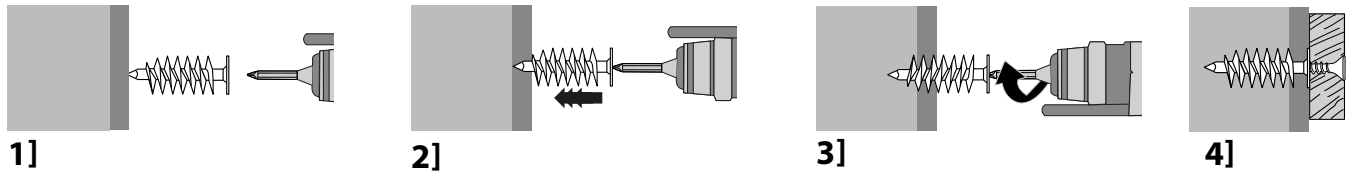
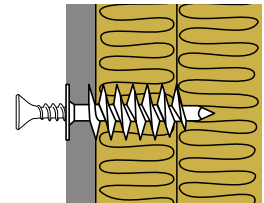
The above mentioned load capacities are provided for guidance only.
 Conditions on load capacity: See page I, ref# 1



TYPE	M	L [mm]		ART. NR.		EAN 13
	27	50	4,0 - 4,5	ISO50	25	5708620103075
	27	80	4,0 - 4,5	ISO80	20	5708620103082

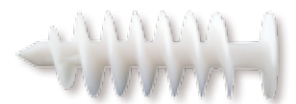





ESI Xtreme Pro Injection Mortar

ESI Xtreme Pro chemische mortel
ESI Xtreme Pro Injektionsmörtel
Mortier chimique Expanded ESI Xtreme Pro
ESI Xtreme Pro Injektionsmasse



FIXINGS FOR CONCRETE AND BRICK

				
cracked concrete	non-cracked concrete	aerated concrete	solid brick	hollow brick

ESI Xtreme Pro - Maximum working time and minimum curing time		
Temperature ¹⁾	Geltime	Curingtime
-10°C → -6°C ²⁾	90 min ²⁾	24 h
-5°C → -1°C	90 min ³⁾	14 h
0°C → +4°C	45 min ³⁾	7 h
+5°C → +9°C	25 min ³⁾	2 h
+10°C → +19°C	15 min ³⁾	80 min
+20°C → +29°C	6 min ³⁾	45 min
+30°C → +34°C	4 min ⁴⁾	25 min
+35°C → +39°C	2 min ⁴⁾	20 min

1) In concrete
* Cartridge temp. Min: + 5°C Max: + 25°C
2) Cartridge temp. Min: + 15°C
3) Cartridge temp.: Must be between +5°C and +25°C (Only acc. EC2 for rebar)
4) Cartridge Temp.: Must be below +20°C (Only acc. EC2 for rebar)
In wet concrete the curing time must be doubled.

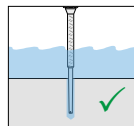
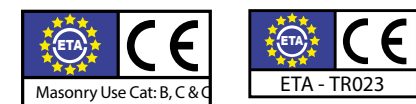
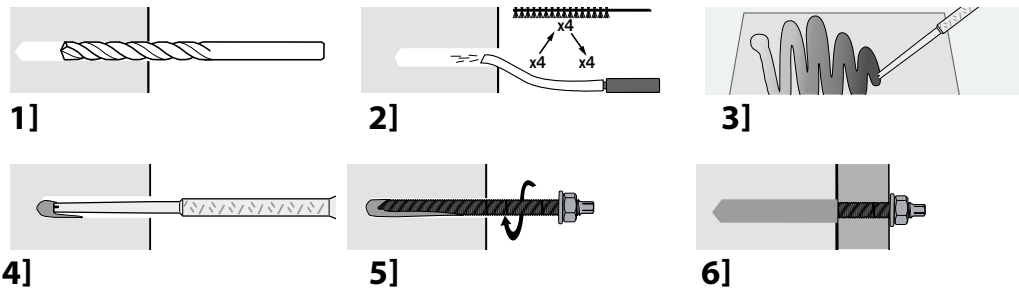

DESIGN AND CALCULATE
YOUR ANCHORAGES IN THE
EXPANDET
CALCULATION
SOFTWARE!





<http://expandet.dk/en/downloads/>



ESI Xtreme Pro Injection Mortar

TYPE
280 ml incl. mixer nozzle
350 ml incl. mixer nozzle
410 ml incl. mixer nozzle
Stock box 20 x art. nr. 800028
Stock box 20 x art. nr. 800350
Stock box 20 x art. nr. 800410

ART. NR.		EAN 13
800028	12	5708620103778
800350	12	5708620103792
800410	12	5708620103761
800028B		5708620103815
800350B		5708620103839
800410B		5708620103822

Design load capacities in non-cracked concrete C20/25

Dimension of threaded rod (mm)	M8	M10	M12	M16	M20	M24	M27	M30
Effective anchorage depth, h_{ef} (mm)	80	90	110	125	170	210	240	270
Drill hole diameter (mm)	10	12	14	18	22	26	30	35
Minimum thickness of submaterial, h_{min} (mm)	110	120	140	161	218	266	304	340
Tension load, Design resistance N_{Rd} kN♦								
4.6 steel	7,5	11,5	17,0	31,5	49,0	70,5	92,0	112,0
5.8 steel	13,4	18,9	27,6	39,2	62,2	85,4	104,3	124,5
8.8 steel	13,4	18,9	27,6	39,2	62,2	85,4	104,3	124,5
A4-70 Stainless Steel	13,4	18,9	27,6	39,2	62,2	85,4	104,3	124,5
A4-80 Stainless Steel	13,4	18,9	27,6	39,2	62,2	85,4	104,3	124,5
HCR steel	13,4	18,9	27,6	39,2	62,2	85,4	104,3	124,5
Shear load, Design resistance V_{Rd} kN♦								
4.6 steel	4,2	7,2	10,2	18,6	29,3	42,5	55,1	67,1
5.8 steel	7,2	12,0	16,8	31,2	48,8	70,4	92,0	112,0
8.8 steel	12,0	18,4	27,2	50,4	78,4	112,8	147,2	179,2
A4-70 Stainless Steel	8,3	12,8	19,2	35,3	55,1	79,5	103,2	125,6
A4-80 Stainless Steel	11,3	17,3	25,6	47,4	73,7	106,0	138,3	168,4
HCR Steel	10,4	16,0	24,0	44,0	68,8	99,2	128,8	156,8

♦ Design resistance is valid for a single anchor in dry/wet non-cracked concrete C20/25 not influenced by edge distance and/or spacing. $\Psi_{re,N} = 1$ (Normal reinforcement according to TR029 5.2.2.3 - 5.2i & 5.2.2.4 - 5.3d).

Design load capacities in cracked concrete C20/25

Dimension of threaded rod (mm)	M8	M10	M12	M16	M20	M24	M27	M30
Effective anchorage depth, h_{ef} (mm)	80	90	110	125	170	210	240	270
Drill hole diameter (mm)	10	12	14	18	24	28	32	35
Minimum thickness of submaterial, h_{min} (mm)	110	120	140	161	218	266	304	340
Tension load, Design resistance N_{Rd} kN♦								
4.6 steel	5,4	7,9	12,7	19,2	32,6	48,4	73,5	88,7
5.8 steel	5,4	7,9	12,7	19,2	32,6	48,4	73,5	88,7
8.8 steel	5,4	7,9	12,7	19,2	32,6	48,4	73,5	88,7
A4-70 Stainless Steel	5,4	7,9	12,7	19,2	32,6	48,4	73,5	88,7
A4-80 Stainless Steel	5,4	7,9	12,7	19,2	32,6	48,4	73,5	88,7
HCR Steel	5,4	7,9	12,7	19,2	32,6	48,4	73,5	88,7
Shear load - Recommended Design resistance V_{Rd} kN♦								
4.6 steel	4,2	7,2	10,2	18,6	29,3	42,5	55,1	67,1
5.8 steel	7,2	12,0	16,8	31,2	48,8	70,4	92,0	112,0
8.8 steel	9,7	18,4	27,0	46,1	78,3	112,8	147,2	179,2
A4-70 Stainless Steel	8,3	12,8	19,2	35,3	55,1	79,5	103,2	125,6
A4-80 Stainless Steel	9,7	17,3	24,1	46,1	73,7	106,0	138,4	168,4
HCR Steel	9,7	16,0	24,0	44,0	68,8	99,2	128,8	156,8

♦ Design resistance is valid for a single anchor in dry/wet cracked concrete C20/25 not influenced by edge distance and/or spacing. $\Psi_{re,N} = 1$ (Normal reinforcement according to TR029 5.2.2.3 - 5.2i & 5.2.2.4 - 5.3d).

Post installed rebar acc. to EN 1992-1-1 (EC2)

Design anchorage lengths for straight rebar ($f_y, k = 500 \text{ N/mm}^2$) post installed with ESI Xtreme Pro in concrete C25/30 acc. to EN 1992-1-1 for "good" bond conditions.

Rebar diameter d_s (mm)	Drill diameter d_0 (mm)	Cross section A_s (mm ²)	Used Design steel capacity (yield) (kN)	Design anchorage Lengths for design to yield	
				$\alpha_2 = 1,0$	Consumption $\alpha_2 = 1,0$
				(mm)	(ml)
8	12	50,3	21,9	378	29
10	14	78,5	34,1	473	43
12	16	113,1	49,2	567	60
14	18	153,9	66,9	662	80
16	20	201,1	87,4	756	103
20	25	314,2	136,6	945	200
22	28	380,1	165,3	1040	294
24	32	452,4	196,7	1134	479
25	32	490,9	213,4	1181	444

1) $\alpha_1 = \alpha_3 = \alpha_4 = \alpha_5 = \alpha_6 = 1,0$. $\gamma_{m,s} = 1,15$ og $\gamma_{m,c} = 1,5$ acc. to EN 1992-1-1.

* Allowed Drilling Method: Hammer or Compressed air drilling.

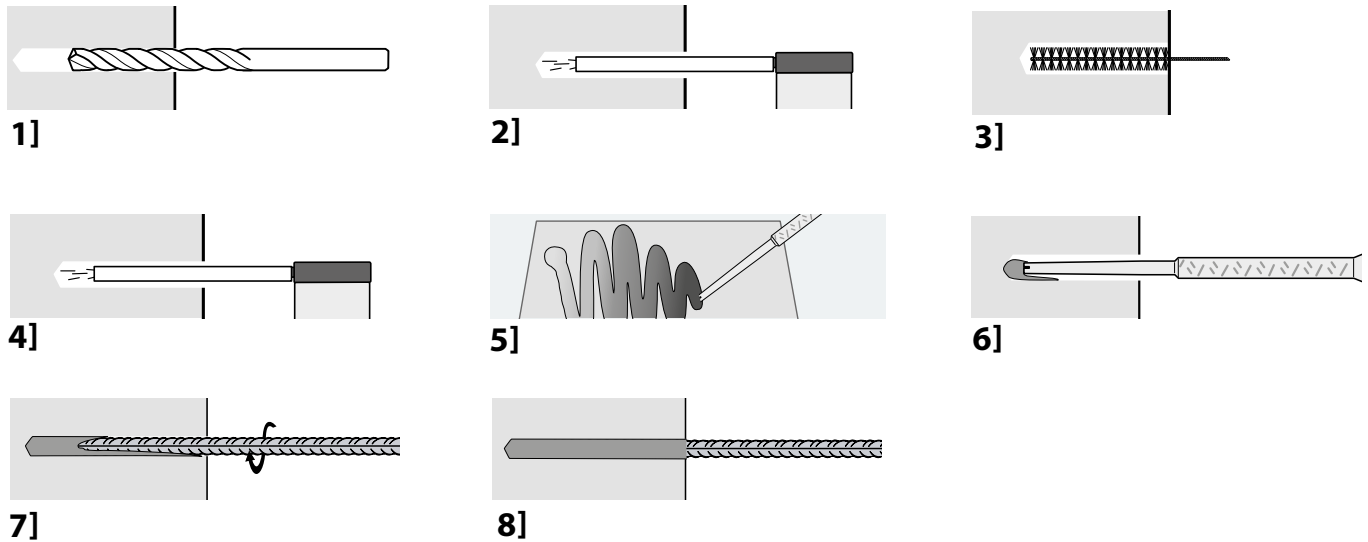

Minimum concrete cover min c of the bonded-in rebar depending on drilling method



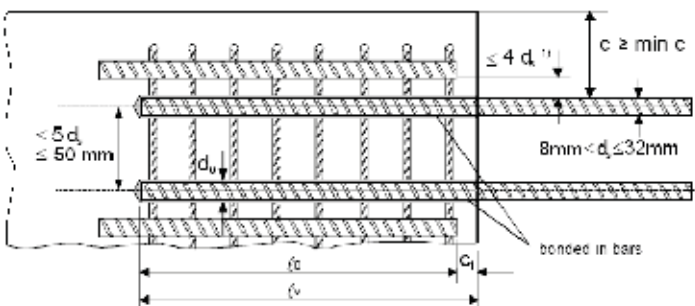

Drilling method	Without drilling aid
Hammer drilling	$40 \text{ mm} + 0,06 l_v \geq 2 d_s$
Compressed air drilling	$60 \text{ mm} + 0,08 l_v$



EVL Xtreme Pro Winter Injection Mortar

EVL Xtreme Pro Winter chemische mortel
EVL Xtreme Pro Injektionsmörtel (Winter)
Mortier chimique EVL Xtreme Pro Hiver
EVL Xtreme Pro Vinter Injektionsmasse



			
cracked concrete	non-cracked concrete	solid brick	hollow brick

FIXINGS FOR CONCRETE AND BRICK

EVL Xtreme Pro - Maximum working time and minimum curing time		
Temperature ¹⁾	Geltime	Curingtime
-20°C → -16°C	90 min	24 h
-15°C → -11°C	90 min	14 h
-10°C → -6°C	45 min	7 h
-5°C → -1°C	25 min	2 h
0°C → +4°C	15 min	80 min
+5°C → +9°C	6 min	45 min
+10°C	4 min	25 min

¹⁾ In concrete
* Cartridge temp. from + 10°C to -20°C
• In wet concrete the curing time must be doubled

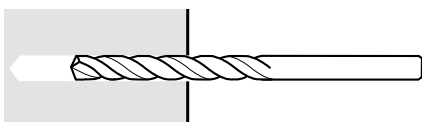

1]

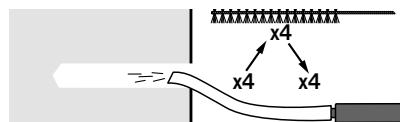

2]

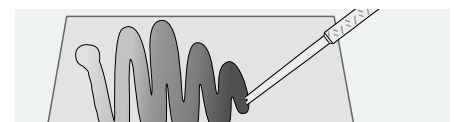

3]

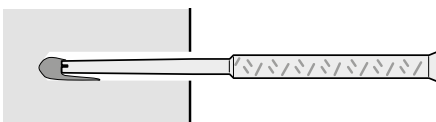

4]

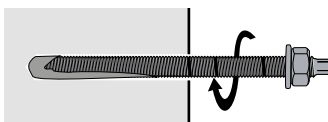

5]



6]

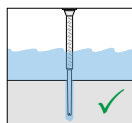

DESIGN AND CALCULATE
YOUR ANCHORAGES IN THE
EXPANDET
CALCULATION
SOFTWARE!



<http://expandet.dk/en/downloads/>





EVL Xtreme Pro Winter Injection Mortar

Styrene free injection mortar in concrete

TYPE DIMENSION

300 ml incl. mixer nozzle
Stock box 20 x art. nr. 805028

ART. NR.		EAN 13
805028	12	5708620103808
805028B		

Professional Injection Gun (H245) is recommended for EVL Xtreme Pro

FIXINGS FOR CONCRETE AND BRICK

Design load capacities in non-cracked concrete C20/25

Dimension of threaded rod (mm)	M8	M10	M12	M16	M20	M24	M27	M30
Effective anchorage depth, h_{ef} (mm)	80	90	110	125	170	210	240	270
Drill hole diameter (mm)	10	12	14	18	22	26	30	35
Minimum thickness of submaterial, h_{min} (mm)	110	120	140	161	218	266	304	340
Tension load, Design resistance N_{Rd} kN♦								
4.6 steel	7,5	11,5	17,0	31,5	49,0	70,5	92,0	112,0
5.8 steel	13,4	18,9	27,6	39,2	62,2	85,4	104,3	124,5
8.8 steel	13,4	18,9	27,6	39,2	62,2	85,4	104,3	124,5
A4-70 Stainless Steel	13,4	18,9	27,6	39,2	62,2	85,4	104,3	124,5
A4-80 Stainless Steel	13,4	18,9	27,6	39,2	62,2	85,4	104,3	124,5
HCR steel	13,4	18,9	27,6	39,2	62,2	85,4	104,3	124,5
Shear load, Design resistance V_{Rd} kN♦								
4.6 steel	4,2	7,2	10,2	18,6	29,3	42,5	55,1	67,1
5.8 steel	7,2	12,0	16,8	31,2	48,8	70,4	92,0	112,0
8.8 steel	12,0	18,4	27,2	50,4	78,4	112,8	147,2	179,2
A4-70 Stainless Steel	8,3	12,8	19,2	35,3	55,1	79,5	103,2	125,6
A4-80 Stainless Steel	11,3	17,3	25,6	47,4	73,7	106,0	138,3	168,4
HCR Steel	10,4	16,0	24,0	44,0	68,8	99,2	128,8	156,8

♦ Design resistance is valid for a single anchor in dry/wet non-cracked concrete C20/25 not influenced by edge distance and/or spacing.
 $\Psi_{re,N} = 1$ (Normal reinforcement according to TR029 5.2.2.3 - 5.2i & 5.2.2.4 - 5.3d).

Design load capacities in cracked concrete C20/25

Dimension of threaded rod (mm)	M8	M10	M12	M16	M20	M24	M27	M30
Effective anchorage depth, h_{ef} (mm)	80	90	110	125	170	210	240	270
Drill hole diameter (mm)	10	12	14	18	24	28	32	35
Minimum thickness of submaterial, h_{min} (mm)	110	120	140	161	218	266	304	340
Tension load, Design resistance N_{Rd} kN♦								
4.6 steel	5,4	7,9	12,7	19,2	32,6	48,4	73,5	88,7
5.8 steel	5,4	7,9	12,7	19,2	32,6	48,4	73,5	88,7
8.8 steel	5,4	7,9	12,7	19,2	32,6	48,4	73,5	88,7
A4-70 Stainless Steel	5,4	7,9	12,7	19,2	32,6	48,4	73,5	88,7
A4-80 Stainless Steel	5,4	7,9	12,7	19,2	32,6	48,4	73,5	88,7
HCR Steel	5,4	7,9	12,7	19,2	32,6	48,4	73,5	88,7
Shear load, Design resistance V_{Rd} kN♦								
4.6 steel	4,2	7,2	10,2	18,6	29,3	42,5	55,1	67,1
5.8 steel	7,2	12,0	16,8	31,2	48,8	70,4	92,0	112,0
8.8 steel	9,7	18,4	27,0	46,1	78,3	112,8	147,2	179,2
A4-70 Stainless Steel	8,3	12,8	19,2	35,3	55,1	79,5	103,2	125,6
A4-80 Stainless Steel	9,7	17,3	24,1	46,1	73,7	106,0	138,4	168,4
HCR Steel	9,7	16,0	24,0	44,0	68,8	99,2	128,8	156,8

♦ Design resistance is valid for a single anchor in dry/wet cracked concrete C20/25 not influenced by edge distance and/or spacing.
 $\Psi_{re,N} = 1$ (Normal reinforcement according to TR029 5.2.2.3 - 5.2i & 5.2.2.4 - 5.3d).

ESI & EVL for fixing of rebar in concrete C20/25

ESI & EVL Mortel voor montage van betonijzer in C20/25 beton

ESI & EVL zur Befestigung von Bewehrungsstahl in Beton C20/25

ESI & EVL pour la fixation de barres d'acier dans le béton C20/25

ESI & EVL for montage af armeringsjern i beton C20/25



Below given design loads do not consider reduction due to edge distances or spacing. The rebar is designed as an anchor and thus do not consider requirements given in EC2 for rebar connections.

In case of the design of post installed rebar acc. to EC2 please see page 54 – for details also see Expandet technical datasheet (ETA acc. EOTA TR023 using ESI Xtreme Pro).



Design load tension capacities

Rebar as an anchor with ESI Xtreme Pro in concrete C20/25.

h ₁	h _{nom}	Rebar diameter (mm)						
		Ø8	Ø10	Ø12	Ø16	Ø20	Ø25	Ø32
		Drill diameter (mm) hammerdrill or compressed air drill						
		12	14	16	20	25	32	40
100	100	14,0	20,9	25,1	28,0	28,0	28,0	
120	120	16,8	25,1	30,2	36,9	36,9	36,9	
140	140	19,5	29,3	35,2	46,5	46,5	46,5	
160	160	20,0	30,7	40,2	53,6	56,8	56,8	56,8
180	180			44,3	52,7	67,8	67,8	67,8
200	200					79,4	79,4	79,4
220	220					91,5	91,5	91,5
240	240					100,5	104,3	104,3
256	256					107,2	114,9	114,9
265	265					111,0	121,0	121,0
280	280					117,3	131,4	131,4
310	310					123,6	147,2	147,2
320	320						151,9	151,9
400	400						189,9	189,9
450	450						192,9	213,6
480	480							277,9
640	640							303,8

Consumption per hole (ml)

h ₁	h _{nom}	Rebar diameter (mm)						
		Ø8	Ø10	Ø12	Ø16	Ø20	Ø25	Ø32
		Drill diameter (mm) hammerdrill or compressed air drill						
		12	14	16	20	25	32	40
100	100	9,1	10,8	12,6	16,3	24,8	43,6	60,5
120	120	10,9	13,0	15,1	19,6	29,8	52,3	72,6
140	140	12,7	15,2	17,6	22,9	34,8	61,0	84,7
160	160	14,5	17,3	20,1	26,1	39,7	69,8	96,8
180	180			22,7	29,4	44,7	78,5	109,0
200	200					49,7	87,2	121,1
220	220					54,6	95,9	133,2
240	240					59,6	104,6	145,3
265	265					65,8	115,5	160,4
280	280					69,5	122,1	169,5
310	310					77,0	135,2	187,6
320	320						139,5	193,7
400	400						174,4	242,1
450	450						196,2	272,4
480	480							290,5
640	640							387,4

1) Design resistance for tension is valid for a single anchor in dry/wet non-concrete C20/25 not influenced by edge distance and/or spacing: $\geq 1,5 \times h_{nom}$ and $\geq 3 \times h_{nom}$.

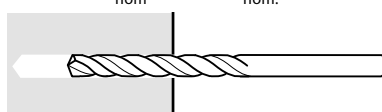

1]

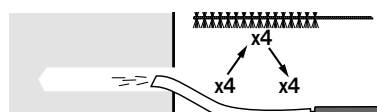

2]

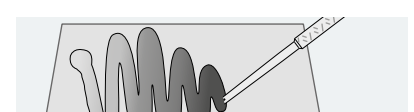

3]

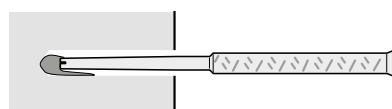

4]

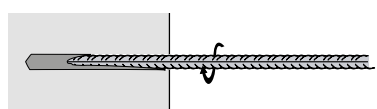

5]

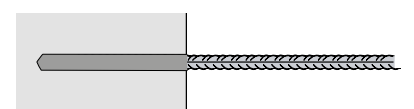





6]

ESP Pro Injection Mortar

ESP Pro chemische mortel
 ESP Pro Injektionsmörtel
 Mortier chimique ESP Pro
 ESP Pro Injektionsmasse



			
non-cracked concrete	aerated concrete	solid brick	hollow brick

ESP Pro - Maximum working time and minimum curing time

Temperature ¹⁾	Geltime	Curingtime
-5°C → -1°C	90 min	360 min
0°C → +4°C	45 min	180 min
+5°C → +9°C	25 min	120 min
+10°C → +14°C	20 min	100 min
+15°C → +19°C	15 min	80 min
+20°C → +29°C	6 min	45 min
+30°C → +34°C	4 min	25 min
+35°C → +39°C	2 min	20 min

¹⁾ In concrete

* Cartridge temp. from + 5°C to + 30°C

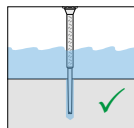
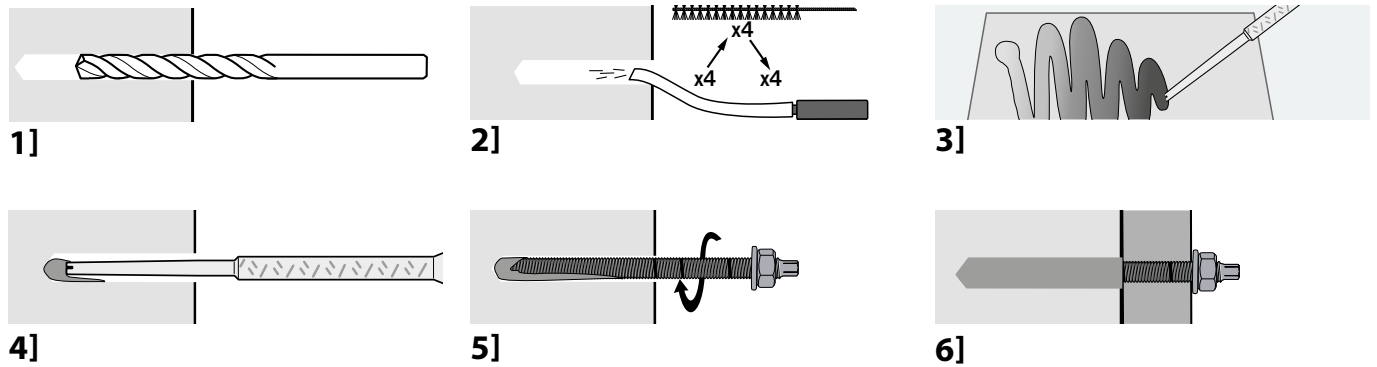

DESIGN AND CALCULATE
 YOUR ANCHORAGES IN THE
EXPANDET
 CALCULATION
SOFTWARE!

<http://expandet.dk/en/downloads/>

FIXINGS FOR CONCRETE AND BRICK

Expandet ESP Pro Injection Mortar

Styrene free injection mortar for concrete



TYPE DIMENSION
300 ml incl. mixer nozzle
Stock box 20 x art. nr. 820300

ART. NR.		EAN 13
820300	10	5708620103846
820300B		5708620103853

Professional Injection Gun (H245) is recommended for ESP Pro

Design load capacities in non-cracked concrete C20/25

Dimension of threaded rod (mm)	M8	M10	M12	M16	M20	M24
Effective anchorage depth, h_{ef} (mm)	80	90	110	125	170	210
Drill hole diameter (mm)	10	12	14	18	22	26
Minimum thickness of submaterial, h_{min} (mm)	110	120	140	161	218	266
Tension load, Design resistance N_{Rd} , kN♦						
4.6 steel	7,5	11,5	17,0	27,9	47,5	70,3
5.8 steel	11,4	12,6	18,4	27,9	47,5	70,3
8.8 steel	11,4	12,6	18,4	27,9	47,5	70,3
A4-70 Stainless Steel	11,4	12,6	18,4	27,9	47,5	70,3
A4-80 Stainless Steel	11,4	12,6	18,4	27,9	47,5	70,3
HCR steel	11,4	12,6	18,4	27,9	47,5	70,3
Shear load, Design resistance V_{Rd} , kN♦						
4.6 steel	4,2	7,2	10,2	18,6	29,3	42,5
5.8 steel	7,2	12,0	16,8	31,2	48,8	70,4
8.8 steel	12,0	18,4	27,2	50,4	78,4	112,8
A4-70 Stainless Steel	8,3	12,8	19,2	35,3	55,1	79,5
A4-80 Stainless Steel	11,3	17,3	25,6	47,4	73,7	106,0
HCR Steel	10,4	16,0	24,0	44,0	68,8	99,2

♦ Design resistance is valid for a single anchor in dry/wet non-cracked concrete C20/25 not influenced by edge distance and/or spacing.
 $\Psi_{re,N} = 1$ (Normal reinforcement according to TR029 5.2.2.3 - 5.2i & 5.2.2.4 - 5.3d).

ESI, EVL & ESP in masonry type solid and hollow bricks

ESI, EVL & ESP Mortel voor metselwerk met massieve en holle baksteen

ESI, EVL & ESP für Voll- und Lochsteinmauerwerk

ESI, EVL & ESP dans briques dures et creuses

ESI, EVL & ESP i massivt murværk og hulsten



FIXINGS FOR CONCRETE AND BRICK

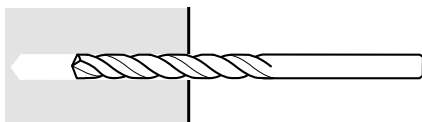

1]

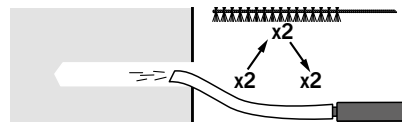

2]

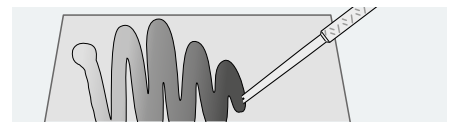

3]

Solid Brick, Aerated Concrete, Lightweight Aggregate Concrete (LAC) and Solid Sand-Lime Brick/Block.

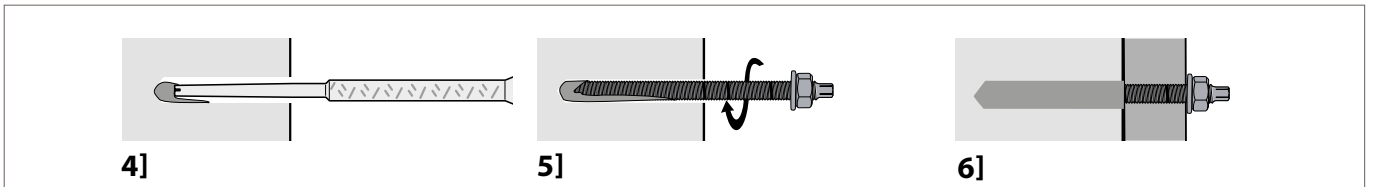

4]

5]

6]

In hollow materials with sleeve.

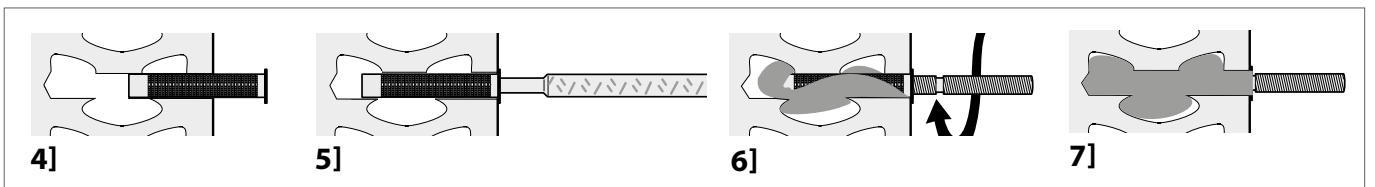

4]

5]

6]

7]

Installation specifics & Design loads for ESI & EVL Xtreme Pro
in different masonry types according to ETA at ambient temperatures (24/40)



ESI & EVL Xtreme Pro in:

Solid Clay Brick (Mz-DF) using hammer or rotary drilling¹⁾

THREADED ROD DIAMETER ³⁾	SLEEVE	DRILL DIAMETER	DRILL/ EMBEDMENT DEPTH IN BRICK (MM)	BRICK SIZE (LENGTH X WIDTH X HEIGHT) (MM)	MIN. COMPRESSIVE STRENGTH (N/MM ²)	DESIGN LOAD, TENSION ²⁾	DESIGN LOAD, SHEAR
(MM)	(MM)	(MM)	(MM)	(MM)	(N/MM ²)	(kN)	(kN)
M8	-	10	80	240 x 115 x 55	20	1,80 (2,65)	2,00 (2,94)
M10	-	12	90			2,20 (3,24)	2,00 (2,94)
M12	-	14	100			2,40 (3,53)	2,00 (2,94)
M16	-	18	100			2,40 (3,53)	3,20 (4,71)

¹⁾ Basic load capacities for the brick without edge distance and/or spacing. For details and other configurations see ETA

²⁾ Values in brackets () are with γ_m 1,7 according to Danish National Annex

³⁾ Threaded rod: Zinc plated or Hot dipped galvanised minimum: \geq 5.6 steel. Stainless steel A4: \geq class 70

Solid Calcium silica Brick KS-NF using hammer or rotary drilling¹⁾

THREADED ROD DIAMETER ³⁾	SLEEVE	DRILL DIAMETER	DRILL/ EMBEDMENT DEPTH IN BRICK (MM)	BRICK SIZE (LENGTH X WIDTH X HEIGHT) (MM)	MIN. COMPRESSIVE STRENGTH (N/MM ²)	DESIGN LOAD, TENSION ²⁾	DESIGN LOAD, SHEAR
(MM)	(MM)	(MM)	(MM)	(MM)	(N/MM ²)	(kN)	(kN)
M8	-	10	80	240 x 115 x 71	20	2,40 (3,53)	1,60 (2,35)
M10	-	12	90			2,40 (3,53)	1,80 (2,65)
M12	-	14	100			2,40 (3,53)	1,60 (2,35)
M16	-	18	100			2,00 (2,94)	1,60 (2,35)

¹⁾ Basic load capacities for the brick without edge distance and/or spacing. For details and other configurations see ETA

²⁾ Values in brackets () are with γ_m 1,7 according to Danish National Annex

³⁾ Threaded rod: Zinc plated or Hot dipped galvanised minimum: \geq 5.6 steel. Stainless steel A4: \geq class 70

Solid light weight concrete (Leca) using rotary drilling only¹⁾

THREADED ROD DIAMETER ³⁾	SLEEVE	DRILL DIAMETER	DRILL/ EMBEDMENT DEPTH IN BRICK (MM)	BRICK SIZE (LENGTH X WIDTH X HEIGHT) (MM)	MIN. COMPRESSIVE STRENGTH (N/MM ²)	DESIGN LOAD, TENSION ²⁾	DESIGN LOAD, SHEAR
(MM)	(MM)	(MM)	(MM)	(MM)	(N/MM ²)	(kN)	(kN)
M8	-	10	80	300 x 123 x 248	2	1,20 (1,76)	1,20 (1,76)
M10	-	12	90			1,40 (2,06)	1,40 (2,06)
M12	-	14	100			1,20 (1,76)	1,40 (2,06)
M16	-	18	100			1,20 (1,76)	1,40 (2,06)

¹⁾ Basic load capacities for the brick without edge distance and/or spacing. For details and other configurations see ETA

²⁾ Values in brackets () are with γ_m 1,7 according to Danish National Annex

³⁾ Threaded rod: Zinc plated or Hot dipped galvanised minimum: \geq 5.6 steel. Stainless steel A4: \geq class 70

Clay Hollow Brick (Doppio Uni) using rotary drilling¹⁾

THREADED ROD DIAMETER ³⁾	SLEEVE	DRILL DIAMETER	DRILL/ EMBEDMENT DEPTH IN BRICK (MM)	BRICK SIZE (LENGTH X WIDTH X HEIGHT) (MM)	MIN. COMPRESSIVE STRENGTH (N/MM ²)	DESIGN LOAD, TENSION ²⁾	DESIGN LOAD, SHEAR
(MM)	(MM)	(MM)	(MM)	(MM)	(N/MM ²)	(kN)	(kN)
M8	16 x 85	16	90	250 x 120 x 120	16	0,30 (0,44)	0,60 (0,88)
M10	16 x 85	16	90			0,30 (0,44)	0,60 (0,88)
M12	20 x 85	20	90			0,30 (0,44)	0,60 (0,88)
M16	20 x 85	20	90			0,30 (0,44)	0,60 (0,88)

¹⁾ Basic load capacities for the brick without edge distance and/or spacing. For details and other configurations see ETA

²⁾ Values in brackets () are with γ_m 1,7 according to Danish National Annex

³⁾ Threaded rod: Zinc plated or Hot dipped galvanised minimum: \geq 5.6 steel. Stainless steel A4: \geq class 70

Installation specifics & Design loads for ESI & EVL Xtreme Pro in different masonry types according ETA at ambient temperatures (24/40)



ESI & EVL Xtreme Pro in:

FIXINGS FOR CONCRETE AND BRICK

Clay hollow brick Calibric R+ using rotary drilling only¹⁾

THREADED ROD DIAMETER ³⁾ (MM)	SLEEVE (MM)	DRILL DIAMETER (MM)	DRILL/ EMBEDMENT DEPTH IN BRICK (MM)	BRICK SIZE (LENGTH X WIDTH X HEIGHT) (MM)	MIN. COMPRESSIVE STRENGTH (N/MM ²)	DESIGN LOAD, TENSION ²⁾ (kN)	DESIGN LOAD, SHEAR (kN)
M8	16 x 85	16	90	500 x 200 x 314	12	0,48 (0,71)	2,20 (3,24)
M8	16 x 130	16	135			0,60 (0,88)	2,20 (3,24)
M10	16 x 85	16	90			0,48 (0,71)	2,20 (3,24)
M10	16 x 130	16	135			0,60 (0,88)	2,20 (3,24)
M12	20 x 85	20	90			0,48 (0,71)	3,40 (5,00)
M16	20 x 85	20	90			0,48 (0,71)	3,40 (5,00)

¹⁾ Basic load capacities for the brick without edge distance and/or spacing. For details and other configurations see ETA

²⁾ Values in brackets () are with $\gamma_m 1,7$ according to Danish National Annex

³⁾ Threaded rod: Zinc plated or Hot dipped galvanised minimum: ≥ 5.6 steel. Stainless steel A4: \geq class 70

Clay hollow brick BGV Thermo using rotary drilling only¹⁾

THREADED ROD DIAMETER ³⁾ (MM)	SLEEVE (MM)	DRILL DIAMETER (MM)	DRILL/ EMBEDMENT DEPTH IN BRICK (MM)	BRICK SIZE (LENGTH X WIDTH X HEIGHT) (MM)	MIN. COMPRESSIVE STRENGTH (N/MM ²)	DESIGN LOAD, TENSION ²⁾ (kN)	DESIGN LOAD, SHEAR (kN)
M8	16 x 85	16	90	500 x 200 x 314	10	0,36 (0,53)	1,40 (2,06)
M8	16 x 130	16	135			0,80 (1,18)	1,60 (2,35)
M10	16 x 85	16	90			0,36 (0,53)	1,40 (2,06)
M10	16 x 130	16	135			0,80 (1,18)	1,60 (2,35)
M12	20 x 85	20	90			0,36 (0,53)	1,60 (2,35)
M16	20 x 85	20	90			0,36 (0,53)	1,60 (2,35)

¹⁾ Basic load capacities for the brick without edge distance and/or spacing. For details and other configurations see ETA

²⁾ Values in brackets () are with $\gamma_m 1,7$ according to Danish National Annex

³⁾ Threaded rod: Zinc plated or Hot dipped galvanised minimum: ≥ 5.6 steel. Stainless steel A4: \geq class 70

Hollow Light weight concrete Bloc B40 using rotary drilling only¹⁾

THREADED ROD DIAMETER ³⁾ (MM)	SLEEVE (MM)	DRILL DIAMETER (MM)	DRILL/ EMBEDMENT DEPTH IN BRICK (MM)	BRICK SIZE (LENGTH X WIDTH X HEIGHT) (MM)	MIN. COMPRESSIVE STRENGTH (N/MM ²)	DESIGN LOAD, TENSION ²⁾ (kN)	DESIGN LOAD, SHEAR (kN)
M8	16 x 85	16	90	494 x 200 x 190	4	0,48 (0,71)	1,20 (1,76)
M8	16 x 130	16	135			0,48 (0,71)	1,20 (1,76)
M10	16 x 85	16	90			0,48 (0,71)	1,20 (1,76)
M10	16 x 130	16	135			0,48 (0,71)	1,20 (1,76)
M12	20 x 85	20	90			0,48 (0,71)	1,20 (1,76)
M16	20 x 85	20	90			0,48 (0,71)	1,20 (1,76)

¹⁾ Basic load capacities for the brick without edge distance and/or spacing. For details and other configurations see ETA

²⁾ Values in brackets () are with $\gamma_m 1,7$ according to Danish National Annex

³⁾ Threaded rod: Zinc plated or Hot dipped galvanised minimum: ≥ 5.6 steel. Stainless steel A4: \geq class 70

Hollow Calcium silicate brick KS L-3DF using rotary drilling only¹⁾

THREADED ROD DIAMETER ³⁾ (MM)	SLEEVE (MM)	DRILL DIAMETER (MM)	DRILL/ EMBEDMENT DEPTH IN BRICK (MM)	BRICK SIZE (LENGTH X WIDTH X HEIGHT) (MM)	MIN. COMPRESSIVE STRENGTH (N/MM ²)	DESIGN LOAD, TENSION ²⁾ (kN)	DESIGN LOAD, SHEAR (kN)
M8	16 x 85	16	90	240 x 175 x 113	14	1,00 (1,47)	2,40 (3,53)
M8	16 x 130	16	135			1,00 (1,47)	2,40 (3,53)
M10	16 x 85	16	90			1,00 (1,47)	2,40 (3,53)
M10	16 x 130	16	135			1,00 (1,47)	2,40 (3,53)
M12	20 x 85	20	90			2,60 (3,82)	2,40 (3,53)
M16	20 x 85	20	90			2,60 (3,82)	2,40 (3,53)

¹⁾ Basic load capacities for the brick without edge distance and/or spacing. For details and other configurations see ETA

²⁾ Values in brackets () are with $\gamma_m 1,7$ according to Danish National Annex

³⁾ Threaded rod: Zinc plated or Hot dipped galvanised minimum: ≥ 5.6 steel. Stainless steel A4: \geq class 70

Installation specifics & Design loads for ESP Pro
in different masonry types according ETA at ambient temperatures (24/40)



ESP Pro in:

Solid Clay Brick (Mz-DF) using hammer or rotary drilling¹⁾							
THREADED ROD DIAMETER³⁾	SLEEVE	DRILL DIAMETER	DRILL/ EMBEDMENT DEPTH IN BRICK (MM)	BRICK SIZE (LENGHT X WIDTH X HEIGHT) (MM)	MIN. COM-PRESSIVE STRENGHT (N/MM²)	DESIGN LOAD, TENSION ²⁾	DESIGN LOAD, SHEAR
(MM)	(MM)	(MM)	(MM)	(MM)	(N/MM²)	(kN)	(kN)
M8	-	10	80	240 x 115 x 55	20	1,0 (1,45)	1,8
M10	-	12	90			1,0 (1,45)	2,2
M12	-	14	100			0,8 (1,18)	3,0
M16	-	18	100			1,4 (2,0)	3,0

¹⁾ Basic load capacities for the brick without edge distance and/or spacing. For details and other configurations see ETA

²⁾ Values in brackets () are with γ_m 1,7 according to Danish National Annex

³⁾ Threaded rod: Zinc plated or Hot dipped galvanised minimum: \geq 5.6 steel. Stainless steel A4: \geq class 70

Aerated Concrete AA2 using rotary drilling only¹⁾							
THREADED ROD DIAMETER³⁾	SLEEVE	DRILL DIAMETER	DRILL/ EMBEDMENT DEPTH IN BRICK (MM)	BRICK SIZE (LENGHT X WIDTH X HEIGHT) (MM)	MIN. COM-PRESSIVE STRENGHT (N/MM²)	DESIGN LOAD, TENSION ²⁾	DESIGN LOAD, SHEAR
(MM)	(MM)	(MM)	(MM)	(MM)	(N/MM²)	(kN)	(kN)
M8	-	10	80	599 x 375 x 249	2	0,45 (0,53)	0,75
M10	-	12	90			0,45 (0,53)	1,0
M12	-	14	100			0,75 (0,87)	1,2
M16	-	18	100			0,75 (0,87)	1,2

¹⁾ Basic load capacities for the brick without edge distance and/or spacing. For details and other configurations see ETA

²⁾ Values in brackets () are with γ_m 1,7 according to Danish National Annex

³⁾ Threaded rod: Zinc plated or Hot dipped galvanised minimum: \geq 5.6 steel. Stainless steel A4: \geq class 70

Aerated Concrete AA4 using rotary drilling only¹⁾							
THREADED ROD DIAMETER³⁾	SLEEVE	DRILL DIAMETER	DRILL/ EMBEDMENT DEPTH IN BRICK (MM)	BRICK SIZE (LENGHT X WIDTH X HEIGHT) (MM)	MIN. COM-PRESSIVE STRENGHT (N/MM²)	DESIGN LOAD, TENSION ²⁾	DESIGN LOAD, SHEAR
(MM)	(MM)	(MM)	(MM)	(MM)	(N/MM²)	(kN)	(kN)
M8	-	10	80	499 x 375 x 249	4	0,45 (0,53)	0,75
M10	-	12	90			1,25 (1,46)	1,0
M12	-	14	100			1,25 (1,46)	1,2
M16	-	18	100			1,75 (2,05)	1,7

¹⁾ Basic load capacities for the brick without edge distance and/or spacing. For details and other configurations see ETA

²⁾ Values in brackets () are with γ_m 1,7 according to Danish National Annex

³⁾ Threaded rod: Zinc plated or Hot dipped galvanised minimum: \geq 5.6 steel. Stainless steel A4: \geq class 70

Solid Calcium silica Brick KS-NF using hammer or rotary drilling¹⁾							
THREADED ROD DIAMETER³⁾	SLEEVE	DRILL DIAMETER	DRILL/ EMBEDMENT DEPTH IN BRICK (MM)	BRICK SIZE (LENGHT X WIDTH X HEIGHT) (MM)	MIN. COM-PRESSIVE STRENGHT (N/MM²)	DESIGN LOAD, TENSION ²⁾	DESIGN LOAD, SHEAR
(MM)	(MM)	(MM)	(MM)	(MM)	(N/MM²)	(kN)	(kN)
M8	-	10	80	240 x 115 x 71	20	1,8 (2,1)	1,80
M10	-	12	90			1,8 (2,1)	1,8
M12	-	14	100			2,2 (3,2)	2,0
M16	-	18	100			1,8 (2,1)	2,0

¹⁾ Basic load capacities for the brick without edge distance and/or spacing. For details and other configurations see ETA

²⁾ Values in brackets () are with γ_m 1,7 according to Danish National Annex

³⁾ Threaded rod: Zinc plated or Hot dipped galvanised minimum: \geq 5.6 steel. Stainless steel A4: \geq class 70

Installation specifics & Design loads for ESP Pro

in different masonry types according ETA at ambient temperatures (24/40)



ESP Pro in:

Clay Hollow Brick (Doppio Uni) using rotary drilling only¹⁾

THREADED ROD DIAMETER ³⁾	SLEEVE	DRILL DIAMETER	DRILL/ EMBEDMENT DEPTH IN BRICK (MM)	BRICK SIZE (LENGTH X WIDTH X HEIGHT) (MM)	MIN. COMPRESSIVE STRENGTH (N/MM ²)	DESIGN LOAD, TENSION ²⁾	DESIGN LOAD, SHEAR
(MM)	(MM)	(MM)	(MM)	(MM)	(N/MM ²)	(kN)	(kN)
M8	16 x 85	16	90	250 x 120 x 120	16	0,48 (0,56)	1,0
M10	16 x 85	16	90			0,48 (0,56)	1,0
M12	20 x 85	20	90			0,60 (0,70)	1,0
M16	20 x 85	20	90			0,60 (0,70)	1,0

¹⁾ Basic load capacities for the brick without edge distance and/or spacing. For details and other configurations see ETA

²⁾ Values in brackets () are with $\gamma_m 1,7$ according to Danish National Annex

³⁾ Threaded rod: Zinc plated or Hot dipped galvanised minimum: ≥ 5.6 steel. Stainless steel A4: \geq class 70

Clay hollow brick HLz-16DF using rotary drilling only¹⁾

THREADED ROD DIAMETER ³⁾	SLEEVE	DRILL DIAMETER	DRILL/ EMBEDMENT DEPTH IN BRICK (MM)	BRICK SIZE (LENGTH X WIDTH X HEIGHT) (MM)	MIN. COMPRESSIVE STRENGTH (N/MM ²)	DESIGN LOAD, TENSION ²⁾	DESIGN LOAD, SHEAR
(MM)	(MM)	(MM)	(MM)	(MM)	(N/MM ²)	(kN)	(kN)
M8	16 x 85	16	90	497 x 238 x 240	12	1,0 (1,47)	0,9
M8	16 x 130	16	135			1,4 (2,06)	1,0
M10	16 x 85	16	90			1,0 (1,47)	0,9
M10	16 x 130	16	135			1,4 (2,06)	1,0
M12	20 x 85	20	90			1,4 (2,06)	0,8
M16	20 x 85	20	90			1,4 (2,06)	0,8

¹⁾ Basic load capacities for the brick without edge distance and/or spacing. For details and other configurations see ETA

²⁾ Values in brackets () are with $\gamma_m 1,7$ according to Danish National Annex

³⁾ Threaded rod: Zinc plated or Hot dipped galvanised minimum: ≥ 5.6 steel. Stainless steel A4: \geq class 70

Clay hollow brick Porottherm Homebric using rotary drilling only¹⁾

THREADED ROD DIAMETER ³⁾	SLEEVE	DRILL DIAMETER	DRILL/ EMBEDMENT DEPTH IN BRICK (MM)	BRICK SIZE (LENGTH X WIDTH X HEIGHT) (MM)	MIN. COMPRESSIVE STRENGTH (N/MM ²)	DESIGN LOAD, TENSION ²⁾	DESIGN LOAD, SHEAR
(MM)	(MM)	(MM)	(MM)	(MM)	(N/MM ²)	(kN)	(kN)
M8	16 x 85	16	90	500 x 200 x 299	8	0,48(0,71)	1,47
M8	16 x 130	16	135			0,60 (0,88)	1,76
M10	16 x 85	16	90			0,48(0,71)	1,47
M10	16 x 130	16	135			0,60 (0,88)	1,76
M12	20 x 85	20	90			0,48(0,71)	2,06
M16	20 x 85	20	90			0,48(0,71)	3,06

¹⁾ Basic load capacities for the brick without edge distance and/or spacing. For details and other configurations see ETA

²⁾ Values in brackets () are with $\gamma_m 1,7$ according to Danish National Annex

³⁾ Threaded rod: Zinc plated or Hot dipped galvanised minimum: ≥ 5.6 steel. Stainless steel A4: \geq class 70

Solid light weight concrete (Leca) using rotary drilling only¹⁾

THREADED ROD DIAMETER ³⁾	SLEEVE	DRILL DIAMETER	DRILL/ EMBEDMENT DEPTH IN BRICK (MM)	BRICK SIZE (LENGTH X WIDTH X HEIGHT) (MM)	MIN. COMPRESSIVE STRENGTH (N/MM ²)	DESIGN LOAD, TENSION ²⁾	DESIGN LOAD, SHEAR
(MM)	(MM)	(MM)	(MM)	(MM)	(N/MM ²)	(kN)	(kN)
M8	-	10	80	498 x 200 x 195	3	0,8 (1,18)	1,20
M10	-	12	90			1,2 (1,76)	1,6
M12	-	14	100			1,2 (1,76)	1,6
M16	-	18	100			1,2 (1,76)	1,6

¹⁾ Basic load capacities for the brick without edge distance and/or spacing. For details and other configurations see ETA

²⁾ Values in brackets () are with $\gamma_m 1,7$ according to Danish National Annex

³⁾ Threaded rod: Zinc plated or Hot dipped galvanised minimum: ≥ 5.6 steel. Stainless steel A4: \geq class 70



FIXINGS FOR CONCRETE AND BRICK

**DESIGN AND
CALCULATE**
YOUR ANCHORAGES IN THE
**EXPANDET
CALCULATION
SOFTWARE!**



<http://expandet.dk/en/downloads/>



Mixer Nozzle

Mengtuiten
Mischerdüse
Mélangeur statique
Mixerrør



for use with Styrene Free Injection Mortar

**TYPE
DIMENSION**

for 300, 350 ml injection mortar

ART. NR.			EAN 13
800002	12		5708620101668

Extension Piece 1m

Verlengstuk 1 m
Bürstenverlängerung 1m
Pièce d'extension de 1m
Forlængerrør 1 meter

for Injection Mortar

**TYPE
DIMENSION**

For Mixer Nozzle

ART. NR.			EAN 13
800001/1M	1		5708620102177

Blow Out Pump

Uitblaaspomp
Ausblasegerät
Soufflette
Bläsepumpe



ART. NR.			
800005	1		5708620100333

Professional Injection Gun H245

Uitdrukpistool, professioneel, H245
 Auspresspistole H245
 Pistolet extracteur professionnel H245
 Proff Injektionspistol H245, plast



for Styrene Free Injections Mortar

TYPE

H245 for 300 ml Injection Mortar

ART. NR.			EAN 13
800019	1		5708620102160

Professional Injection Gun H260

Uitdrukpistool, professioneel, H260, kunststof
 Auspresspistole H260, Kunststoff
 Pistolet extracteur Expanded professionnel H260, plastique
 Proff Injektionspistol 260, plast



Plastic for 300d 345 cartridges, for Styrene Free Injections Mortar

TYPE

H260 for 300 and 350 ml Injection Mortar
--

ART. NR.			EAN 13
800045	1		5708620102207

Accessory Box for Injection Mortar

Accessoires koffer voor chemische mortel
 Zubehörkoffer für Injektionsmörtel
 Coffret d'accessoires Expanded pour mortier chimique
 Kuffert med tilbehør til injektionsmasse



TYPE	PCS.
------	------

Mixer Nozzle	3
Injection Gun H260 (800045)	1
Blow Out Pump	1
Brush Ø13	1
Brush Ø19	1
Brush Ø27	1

ART. NR.			EAN 13
----------	---	--	--------

000167	1		5708620017396
--------	---	--	---------------

Brush

Boorgat reinigingsborstel
 Reinigungsbürste
 Brosse de nettoyage
 Børste

for cleaning of drilled holes

TYPE DIMENSION

Ø13 for hole 8 - 10 mm
Ø19 for hole 12 - 16 mm
Ø27 for hole 20 - 24 mm



ART. NR.			EAN 13
800010EX	1		5708620100388
800011	1		5708620100395
800020	1		5708620100357

Handle for Brush

Handgreep voor reinigingsborstel
 Griff für Reinigungsbürste
 Poignée pour brosse de nettoyage
 Håndtag for børste

TYPE DIMENSION

Handle for Brush - Length 300 mm



ART. NR.			EAN 13
800057	1		5708620102399

Extension Piece for Brush

Verlengstuk voor reinigingsborstel
 Verlängerung für Reinigungsbürste
 Extension pour brosse de nettoyage
 Forlængerstykke til børste

TYPE DIMENSION

Extention Piece - Length 300 mm



ART. NR.			EAN 13
800056	1		5708620102382

Brush without Handle

Reinigingsborstel zonder handgreep
 Reinigungsbürste ohne Griff
 Brosse de nettoyage sans poignée
 Børste uden håndtag



TYPE DIMENSION	LENGTH MM
Brush without handle Ø14	300
Brush without handle Ø19	300
Brush without handle Ø24	300
Brush without handle Ø29	300
Brush without handle Ø41	300

ART. NR.	QTY	EAN 13
800051	1	5708620102337
800052	1	5708620102344
800053	1	5708620102351
800054	1	5708620102368
800055	1	5708620102375

Sleeve

Zeefhuls
 Siebhülse
 Tamis
 Sihylse



TYPE DIMENSION MM	THREADED ROD	d ₀ [mm]
12 x 50	M8	12
16 x 85	M10 - M12	16
16 x 130	M10 - M12	16
20 x 85	M12 - M16	20
12 x 1000	M8	12
16 x 1000	M10 - M12	16
22 x 1000	M16 - M14	22





ART. NR.	QTY	EAN 13
809050	10	5708620100401
813085	10	5708620100418
813130	10	5708620100425
818085	10	5708620100432
8121000	1	5708620100449
8161000	1	5708620100456
8221000	1	5708620100463

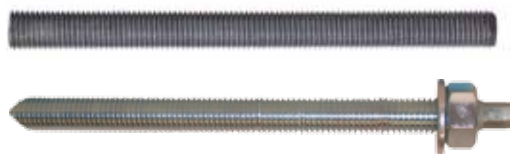

Threaded Rods, Nuts and Washers

Draadeinden, Moeren en Ringen
Gewindestangen, Sechskantmuttern und Unterlegscheiben
Tiges filetées, écrous et rondelles
Gevindstænger, møtrikker og skiver



				
cracked concrete	non-cracked concrete	aerated concrete	solid brick	hollow brick



Threaded Rod with nut and washer, pointed, zinc plated



TYPE	DIMENSION
EGS-EG	8 x 110
EGS-EG	10 x 130
EGS-EG	12 x 160
EGS-EG	16 x 190

ART. NR.		EAN 13
900108S	10	5708620097572
900110S	10	5708620097589
900112S	10	5708620097596
900116S	10	5708620097602



Threaded Rod with nut and washer, pointed, hot dipped galvanized

TYPE	DIMENSION
EGS-VG	8 x 110
EGS-VG	10 x 130
EGS-VG	12 x 160
EGS-VG	16 x 190

ART. NR.		EAN 13
900108VGS	10	5708620100654
900110VGS	10	5708620100661
900112VGS	10	5708620100678
900116VGS	10	5708620100685



Threaded Rod with nut and washer, pointed, INOX A4

TYPE	DIMENSION	
EGS-A4	8 x 110	
EGS-A4	8 x 150	*
EGS-A4	10 x 130	
EGS-A4	10 x 165	*
EGS-A4	12 x 160	
EGS-A4	12 x 190	*
EGS-A4	16 x 170	*
EGS-A4	16 x 190	
EGS-A4	20 x 260	
EGS-A4	24 x 300	*

ART. NR.		EAN 13
900108A4 S	10	5708620100715
908150A4 S	10	5708620102061
900110A4 S	10	5708620100722
910165A4 S	10	5708620102078
900112A4 S	10	5708620100739
912190A4 S	10	5708620102085
916170A4 S	10	5708620102092
900116A4 S	10	5708620100746
900120A4 S	10	5708620100753
900124A4 S	10	5708620100760

* Available on request

Threaded Rod, straight cut, zinc plated

Draadeind, recht eind, verzinkt
Gewindestange, verzinkt
Tige filetée avec embout droit, zinguée
Gevindstang lige afskåret, el-galvaniseret



TYPE	DIMENSION
EGL-EG	8 x 110
EGL-EG	8 x 150
EGL-EG	10 x 130
EGL-EG	10 x 160
EGL-EG	12 x 160
EGL-EG	12 x 190
EGL-EG	12 x 220
EGL-EG	16 x 170
EGL-EG	16 x 190

ART. NR.			EAN 13
908110	50		5708620102535
908150	50		5708620102542
910130	50		5708620102559
910160	50		5708620102566
912160	50		5708620102573
912190	50		5708620102580
912220	50		5708620102597
916170	50		5708620102603
916190	25		5708620102610

FIXINGS FOR CONCRETE AND BRICK

Threaded Rod, straight cut, hot dipped galvanized

Draadeind, recht eind, thermisch verzinkt
Gewindestange, Feuerverzinkt
Tige filetée avec embout droit, gavanisé à chaud
Gevindstang lige afskåret, varm-galvaniseret







TYPE	DIMENSION
EGL-VG	8 x 110
EGL-VG	8 x 150
EGL-VG	10 x 130
EGL-VG	10 x 160
EGL-VG	12 x 160
EGL-VG	12 x 190
EGL-VG	12 x 220
EGL-VG	16 x 170
EGL-VG	16 x 190

ART. NR.			EAN 13
0908110VG	50		5708620102627
0908150VG	50		5708620102634
0910130VG	50		5708620102641
0910160VG	50		5708620102658
0912160VG	50		5708620102665
0912190VG	50		5708620102672
0912220VG	50		5708620102689
0916170VG	50		5708620102696
0916190VG	25		5708620102702

Socket Anchor with internal thread*

Huls met binnendraad
 Innengewindehülse
 Douille avec filet interne
 Gevindhylse til injektionsmasse



				
cracked concrete	non-cracked concrete	aerated concrete	solid brick	hollow brick



FIXINGS FOR CONCRETE AND BRICK

Type	Load capacities
DIMENSION	N_{Rd}
	Design resistance, tension
	kN
M6	3,50
M8	5,00
M10	8,00
M12	8,00

Conditions on load capacity: See page I, ref# 4
 * To be used in combination with ESI, EVL or ESP chemical mortar

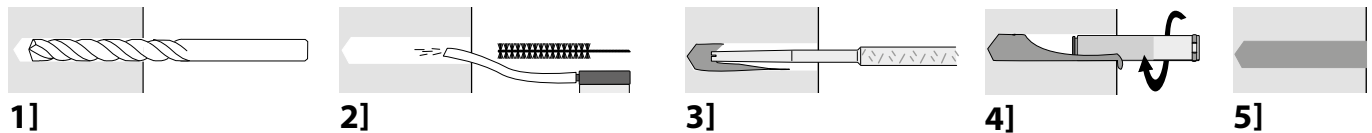

TYPE	in brick and concrete wall, [mm]	d_0 with Sleeve [mm]	OUTSIDE M [mm]	ART. NR.		EAN 13
6 x 48	10	12	8	980106	10	5708620100562
8 x 80	14	16	12	980108	10	5708620100531
10 x 80	16	20	14	980110	10	5708620100548
12 x 80	18	20	16	980112	10	5708620100555

(Given dimensions are the internal diameter x total length)

C-Bolt with flange

C-Bolt Betonschroef met flens



C-Bolt Betonschraube mit Flansch

C-Bolt Vis pour béton avec rondelle

C-Bolt med Flange



FIXINGS FOR CONCRETE

		
cracked concrete	non-cracked concrete	solid base materials

Type *	Design Load Capacities					
	DIAMETER (t _{fix} [mm] 1,2,3) mm	h _{nom} [mm] 1,2,3 mm	Non-cracked concrete		Cracked concrete	
			Tension load N _{Rd}	Shear load V _{Rd}	Tension load N _{Rd}	Shear load V _{Rd}
Ø5 - 6 x 40 (5)		35	1,1	1,1	0,8	0,8
Ø5 - 6 x 50 (15/5)		35/45	1,1 / 1,7	1,2 / 1,7	0,8/1,2	0,8/1,3
Ø5 - 6 x 75 (30/20)		35/45	1,1 / 1,8	1,2 / 1,8	0,8/1,2	0,8/1,3
Ø6 - 8 x 30 (1)		29	1,2	1,2	0,8	0,8
Ø6 - 8 x 50 (15)		35	1,7	1,7	1,1	1,1
Ø6 - 8 x 80 (45/25)		35/55	1,7/4,2	1,7/4,3	1,1/2,8	1,1/2,8
Ø8 - 10 x 60 (15/10)		45/50	3,3/3,3	3,3/3,3	1,6/2,2	1,6/2,2
Ø8 - 10 x 75 (30/25/10)		45/50/65	3,3/3,3/6,6	3,3/3,3/6,6	1,6/2,2/2,4	1,6/2,2/4,1
Ø8 - 10 x 100 (55/50/35)		45/50/65	3,3/3,3/6,6	3,3/3,3/6,6	1,6/2,2/2,4	1,6/2,2/4,1
Ø8 - 10 x 130 (85/80/65)		45/50/65	3,3/3,3/6,6	3,3/3,3/6,6	1,6/2,2/2,4	1,6/2,2/4,1
Ø10 - 12 x 60 (10)		50	5,4	5,4	3,9	3,9
Ø10 - 12 x 85 (35/25/10)		50/60/75	5,4/5,4/8,8	5,4/5,4/8,8	3,9/3,9/5,0	3,9/3,9/5,0
Ø10 - 12 x 100 (50/40/25)		50/60/75	5,4/5,4/8,8	5,4/5,4/8,8	3,9/3,9/5,0	3,9/3,9/5,0
Ø10 - 12 x 130 (80/70/55)		50/60/75	5,4/5,4/8,8	5,4/5,4/8,8	3,9/3,9/5,0	3,9/3,9/5,0
Ø14 - 16 x 80 (20/10)		60/70	9,1/9,1	18,2/18,2	7,0/7,0	14,0/14,0
Ø14 - 16 x 120 (60/50/5)		60/70/115	9,1/9,1/19,4	18,2/18,2/35,6	7,0/7,0/11,1	14,0/14,0/22,2

* How to read the "Type" colour:

d ₀ [mm]	d	L [mm]	t _{fix} [mm]
↓	↓	↓	↓
Ø8	10	x 100	① ② ③ (55 / 50 / 35)

Conditions on load capacity: See page I, ref# 4

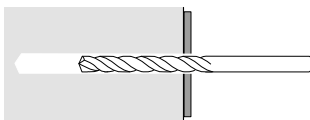

1]

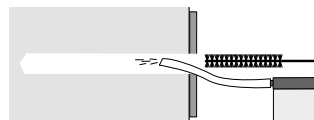

2]

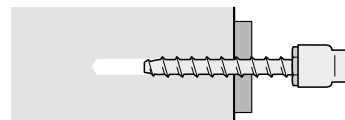

3]

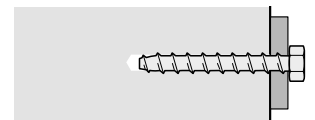

4]

DESIGN AND CALCULATE
YOUR ANCHORAGES IN THE
EXPANDET
CALCULATION
SOFTWARE!





<http://expandet.dk/en/downloads/>



C-Bolt



TYPE	d_0 [mm] 	h_1 [mm] 1, 2, 3 mm	h_{nom} [mm] 1, 2, 3 mm	h_{ef} [mm] 1, 2, 3 mm	ART. NR.		EAN 13
Ø5 - 6 x 40 (5)	5	45	35	25	C906040	200	5708620211626
Ø5 - 6 x 50 (15/5)	5	55/45	35/45	35/25	C906050	200	5708620211633
Ø5 - 6 x 75 (30/20)	5	55/45	35/45	35/25	C906075	200	5708620211640
Ø6 - 8 x 30 (1)	6	40	29	19	C908030	200	5708620211657
Ø6 - 8 x 50 (15)	6	45	35	25	C908050	200	5708620211664
Ø6 - 8 x 80 (45/25)	6	65/45	35/55	40/25	C908080	100	5708620211671
Ø6 - 8 x 100 (65/45)	6	65/45	35/55	40/25	C908100	100	5708620211688
Ø8 - 10 x 60 (15/10)	8	55/60	45/50	30/34	C910060	100	5708620209906
Ø8 - 10 x 75 (30/25/10)	8	55/60/75	45/50/65	30/34/37	C910075	50	5708620209913
Ø8 - 10 x 100 (55/50/35)	8	55/60/75	45/50/65	30/34/37	C910100	50	5708620209920
Ø8 - 10 x 130 (85/80/65)	8	55/60/75	45/50/65	30/34/37	C910130	50	5708620209937
Ø10 - 12 x 60 (10)	10	60	50	33	C912060	50	5708620209944
Ø10 - 12 x 85 (35/25/10)	10	60/70/85	50/60/75	30/42/54	C912085	50	5708620209951
Ø10 - 12 x 100 (50/40/25)	10	60/70/85	50/60/75	30/42/54	C912100	50	5708620209968
Ø10 - 12 x 130 (80/70/55)	10	60/70/85	50/60/75	30/42/54	C912130	25	5708620209975
Ø14 - 16 x 80 (20/10)	14	70/80	60/70	40/48	C916080	25	5708620209982
Ø14 - 16 x 120 (60/50/5)	14	70/80/125	60/70/115	40/48/86	C916120	20	5708620209999

ETA, Option 1, CE-marked
Fire classification: R120

* How to read the "type-coloum":

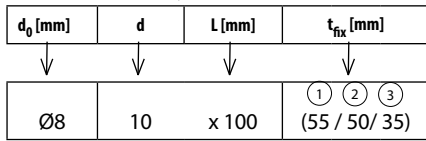



FIXINGS FOR CONCRETE

MMS Concrete Bolt

MMS Betonschroef
MMS Betonschraube
Vis pour béton MMS
MMS Betonbolt



		
cracked concrete	non-cracked concrete	solid base materials



FIXINGS FOR CONCRETE

Type	Design Load Capacities					
	DIAMETER	h_{nom} [mm]	Non-cracked concrete		Cracked concrete	
			Tension load N_{Rd}	Shear load V_{Rd}	Tension load N_{Rd}	Shear load V_{Rd}
MMS-S 6	•	35	2,7	3,9	1,9	2,7
MMS-S 6	•	45	3,7	3,9	2,0	3,6
MMS-S 7,5		35	2,7	4,1	1,3	3,2
MMS-S 7,5	•	45	3,3	4,6	2,2	4,6
MMS-S 7,5		55	4,1	4,6	2,8	4,6
MMS-S 10	•	55	5,6	10,7	4,1	10,7
MMS-S 10		65	6,6	10,7	5,0	10,7
MMS-S 12	•	55	6,4	15,3	4,6	10,9
MMS-S 12		75	8,8	17,3	6,6	15,3
MMS-S 14		95	16,6	24,0	11,1	24,0
MMS-S 16 x 80	•	70	13,0	30,2	9,4	22,3
MMS-S 16 x 120	•	110	22,9	32,6	16,4	32,6
MMS-S 16 x 150		115	22,9	32,6	16,4	32,6
MMS-S 20 x 100	•	90	14,1	33,9	10,1	24,2
MMS-S 20 x 130	•	115	21,8	52,5	15,6	37,5

• Not included in ETA-Assessment.

Conditions on load capacity: See page I, ref# 4

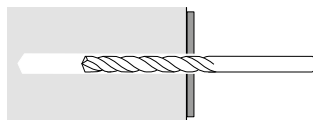
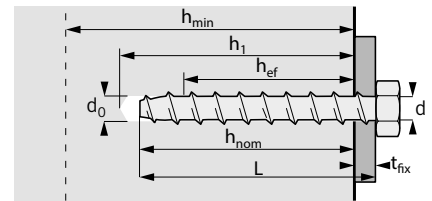

1]

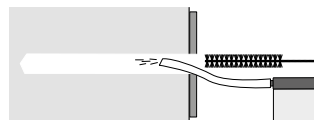

2]

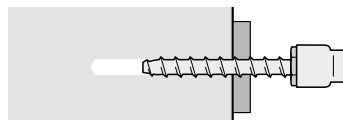

3]

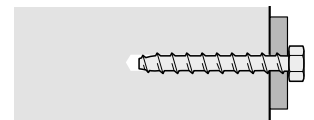

4]





DESIGN AND CALCULATE
YOUR ANCHORAGES IN THE
EXPANDET
CALCULATION
SOFTWARE!

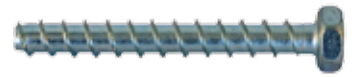

<http://expandet.dk/en/downloads/>

MMS Concrete Bolt, zinc plated





TYPE	DIMENSION		t_{fx} [mm]	h_1 [mm]	h_{nom} [mm]	h_{ef} [mm]	ART. NR.		EAN 13	
MMS-S	6 x 40	•	5	5	45	35	23,8	SK906040	200	5708620200897
MMS-S	6 x 50	•	5	5	55	45	32,3	SK906050	100	5708620200903
MMS-S	6 x 60	•	5	15	55	45	32,3	SK906060	100	5708620200910
MMS-S	6 x 80	•	5	35	55	45	32,3	SK906080	50	5708620200927
MMS-S	6 x 100	•	5	55	55	45	32,3	SK906100	50	5708620200934
MMS-S	7,5 x 35		6	1	40	35	26,0	SK975035	100	5708620200941
HMS-S	7,5 x 40		6	5	40	35	26,0	SK975040	100	5708620200958
MMS-S	7,5 x 45	•	6	1	50	45	31,5	SK975045	100	5708620200965
MMS-S	7,5 x 50	•	6	5	50	45	31,5	SK975050	100	5708620200972
MMS-S	7,5 x 60		6	5	60	55	40,0	SK975060	100	5708620200880
MMS-S	7,5 x 80		6	25	60	55	40,0	SK975080	50	5708620200989
MMS-S	7,5 x 100		6	45	60	55	40,0	SK975100	50	5708620200996
MMS-S	7,5 x 120		6	65	60	55	40,0	SK975120	50	5708620201009
MMS-S	7,5 x 140		6	85	60	55	40,0	SK975140	50	5708620201016
MMS-S	10 x 60	•	8	5	65	55	39,0	SK910060	50	5708620201023
MMS-S	10 x 70		8	5	75	65	47,5	SK910070	50	5708620201030
MMS-S	10 x 80		8	15	75	65	47,5	SK910080	50	5708620201047
MMS-S	10 x 100		8	35	75	65	47,5	SK910100	25	5708620201054
MMS-S	10 x 120		8	55	75	65	47,5	SK910120	25	5708620201061
MMS-S	10 x 140		8	75	75	65	47,5	SK910140	25	5708620201078
MMS-S	10 x 160		8	95	75	65	47,5	SK910160	25	5708620201085
MMS-S	12 x 60	•	10	5	65	55	37,4	SK912060	25	5708620201092
MMS-S	12 x 80		10	5	85	75	54,5	SK912080	25	5708620201108
MMS-S	12 x 90		10	15	85	75	54,5	SK912090	25	5708620201115
MMS-S	12 x 100		10	25	85	75	54,5	SK912100	25	5708620200866
MMS-S	12 x 120		10	45	85	75	54,5	SK912120	25	5708620201122
MMS-S	12 x 140		10	69	85	75	54,5	SK912140	25	5708620201139
MMS-S	12 x 160		10	85	85	75	54,5	SK912160	25	5708620200873
MMS-S	12 x 200		10	125	85	75	54,5	SK912200	25	5708620200644
MMS-S	12 x 240		10	165	85	75	54,5	SK912240	25	5708620202914
MMS-S	12 x 280		10	205	85	75	54,5	SK912280	25	5708620202921
MMS-S	12 x 320		10	245	85	75	54,5	SK912320	25	5708620202938
MMS-S	14 x 110		12	15	105	95	71,5	SK914110	25	5708620202051
MMS-S	14 x 130		12	35	105	95	71,5	SK914130	25	5708620202068
MMS-S	14 x 150		12	55	105	95	71,5	SK914150	25	5708620202075
MMS-S	16x 80	•	14	10	80	70	60,0	SK916080	25	5708620201146
MMS-S	16x120	•	14	5	120	110	87,5	SK916120	10	5708620201153
MMS-S	16x150		14	35	130	115	87,5	SK916150	10	5708620201160
MMS-S	20x100	•	18	10	100	90	63,5	SK920100	10	5708620201177
MMS-S	20x130	•	18	15	125	115	85,0	SK920130	10	5708620201184

FIXINGS FOR CONCRETE

MMS Concrete Bolt, Delta Protekt



TYPE	DIMENSION		d_0 [mm]	t_{fx} [mm]	h_1 [mm]	h_{nom} [mm]	h_{ef} [mm]	ART. NR.		EAN 13
MMS-S	7,5 x 50	•	6	5	50	45	31,5	SKD975050	100	5708620203515
MMS-S	7,5 x 60		6	5	60	55	40,0	SKD975060	100	5708620203522
MMS-S	10 x 60	•	8	5	65	55	39,0	SKD910060	50	5708620203362
MMS-S	10 x 80		8	15	75	65	47,5	SKD910080	50	5708620203379
MMS-S	10 x100		8	35	75	65	47,5	SKD910100	25	5708620203386
MMS-S	10 x120		8	55	75	65	47,5	SKD910120	25	5708620203393
MMS-S	12 x 60	•	10	5	65	55	37,4	SKD912060	25	5708620203409
MMS-S	12 x 80		10	5	85	75	54,5	SKD912080	25	5708620203416
MMS-S	12 x 90		10	15	85	75	54,5	SKD912090	25	5708620203423
MMS-S	12 x100		10	25	85	75	54,5	SKD912100	25	5708620203430
MMS-S	12 x120		10	45	85	75	54,5	SKD912120	25	5708620203447

NOTE: Delta Protekt going out of range and will be replaced by ZnNi surface in 2017

ETA, Option 1, CE-marked

Fire classification: R120

- Not included in ETA-Assessment

FIXINGS FOR CONCRETE



MMS Concrete Bolt, INOX A4 (316)

- MMS Betonschroef RVS A4 (316)
- MMS Betonschraube Edelstahl A4 (316)
- Vis pour béton MMS , Inox A4 (316)
- MMS Betonbolt INOX A4 (316)



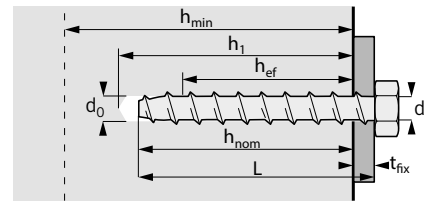

		
cracked concrete	non-cracked concrete	solid base materials

Type	Design Load Capacities					
	DIAMETER	h_{nom} [mm]	Non-cracked concrete		Cracked concrete	
			Tension load N_{Rd}	Shear load V_{Rd}	Tension load N_{Rd}	Shear load V_{Rd}
MMS-S 7,5 x 75	65	3,5	6	2,4	6	
MMS-S 10 x 85	75	6,6	13,3	5	13,3	
MMS-S 10 x 95	75	6,6	13,3	5	13,3	
MMS-S 12 x 100	90	8,8	22	6,6	19,3	
MMS-S 12 x 120	90	8,8	22	6,6	19,3	

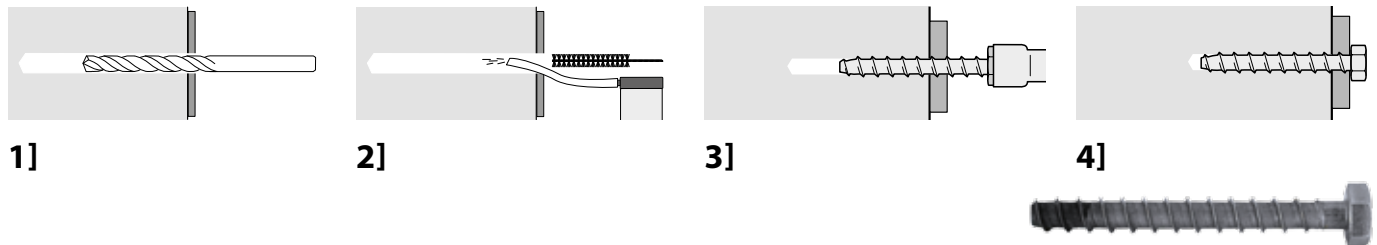

Conditions on load capacity: See page I, ref# 4



TYPE	DIMENSION	d_0 [mm]	t_{fix} [mm]	h_1 [mm]	h_{nom} [mm]	h_{ef} [mm]	ART. NR.		EAN 13
MMS-S	7,5 x 60/ 75	6	10	70	65	40,0	SK975075R	50	5708620201191
MMS-S	10 x 70/ 85	8	10	90	75	47,5	SK910085R	25	5708620201207
MMS-S	10 x 80/ 95	8	20	90	75	47,5	SK910095R	25	5708620201214
MMS-S	12 x 80/100	10	10	100	90	54,5	SK912100R	25	5708620201221
MMS-S	12 x 100/120	10	30	100	90	54,5	SK912120R	25	5708620201238

ETA, Option 1, CE-marked
Fire classification: R120

DESIGN AND CALCULATE
YOUR ANCHORAGES IN THE
EXPANDET
CALCULATION
SOFTWARE!



<http://expandet.dk/en/downloads/>



FIXINGS FOR CONCRETE

MMS Concrete Bolt

MMS Betonschroef
MMS Betonschraube
Vis pour béton MMS
MMS Betonbolt



FIXINGS FOR CONCRETE

		
cracked concrete	non-cracked concrete	solid base materials

Type		Design Load Capacities				
DIAMETER	h_{nom} [mm]	Non-cracked concrete		Cracked concrete		
		Tension load N_{Rd}	Shearload V_{Rd}	Tension load N_{Rd}	Shearload V_{Rd}	
MMS-I	7,5 x 40	35	2,7	4,1	1,3	3,2
MMS-I	7,5 x 55	55	4,1	-	2,8	-
MMS-ST	6 x 60 (M6x8)	50	4,2	-	3,6	-
MMS-ST	7,5x70 (M8x14)	50	3,6	-	2,5	-
MMS-ST	10 x 80 (M10x11)	55	5,6	-	4,1	-
MMS-MS	7,5 x 35	35	2,7	4,1	1,3	3,2
MMS-MS	7,5 x 40	35	2,7	4,1	1,3	3,2
MMS-MS	7,5 x 50	45	3,3	4,6	2,2	4,6
MMS-P	5 x 30	30	1,8	2,6	1,3	2,2
MMS-P	5 x 50	35	2,5	2,6	1,8	2,6
MMS-F	6 x 40	30	2,0	3,5	1,4	2,5
MMS-F	6 x 60	45	3,0	3,9	2,0	3,6
MMS-F	6 x 80	45	3,0	3,9	2,0	3,6
MMS-R	6 x 40	40	2,2	-	1,6	-

• Not included in ETA-Assessment.

Conditions on load capacity: See page I, ref# 4

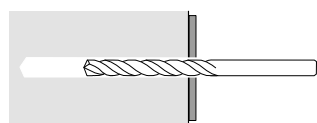
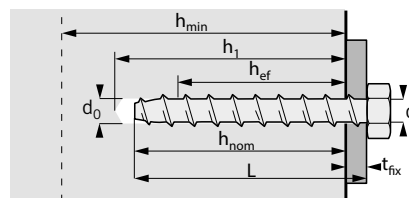

1]

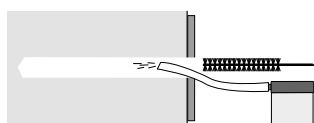

2]

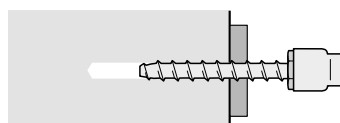

3]

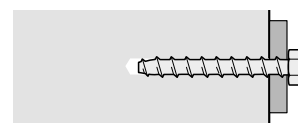

4]

DESIGN AND CALCULATE
YOUR ANCHORAGES IN THE
EXPANDET
CALCULATION
SOFTWARE!





<http://expandet.dk/en/downloads/>



MMS concrete bolt with flange



TYPE	DIMENSION	d_0 [mm]	t_{fx} [mm]	h_1 [mm]	h_{nom} [mm]	h_{ef} [mm]	ART. NR.		EAN 13
MMS	7,5 x 50	6	5	50	45	31,5	SKF975050	50	5708620202860
MMS	10,0 x 80	8	15	75	65	47,5	SKF910080	25	5708620202891
MMS	12,0 x 90	10	15	85	75	54,5	SKF912090	25	5708620202907

ETA, Option 1, CE-marked
 Fire classification: R120
 • Not included in ETA-Assessment

MMS concrete bolt with internal combi thread, zinc plated.



TYPE	DIMENSION	d_0 [mm]	t_{fx} [mm]	h_1 [mm]	h_{nom} [mm]	h_{ef} [mm]	ART. NR.		EAN 13
MMS-I	7,5 x 40	6	5	40	35	26	SK975040I	40	5708620211725
MMS-I	7,5 x 60	6	M8 / M10	60	55	40,0	SK975055I	50	5708620201245

ETA, Option 1, CE-marked
 Fire classification: R120

MMS concrete bolt with external thread, zinc plated.



TYPE	DIMENSION	d_0 [mm]	t_{fx} [mm]	h_1 [mm] 1, 2, 3 mm	h_{nom} [mm] 1, 2, 3 mm	h_{ef} [mm] 1, 2, 3 mm	ART. NR.		EAN 13
MMS-ST	6x60 (M 6x 5)	5	15	55	50	36,5	SK906060M	100	5708620201252
MMS-ST	7,5x70 (M 8x14)	6	25	55	50	36,0	SK975070M	50	5708620201269
MMS-ST	10x80 (M10x11)	8	25	65	55	39,0	SK910080M	50	5708620201276

Fire classification: R120
 • Not included in ETA-Assessment

MMS concrete bolt with large head (17 mm)



TYPE	DIMENSION	d_0 [mm]	t_{fx} [mm]	h_1 [mm]	h_{nom} [mm]	h_{ef} [mm]	ART. NR.		EAN 13
MMS-MS	7,5 x 35	6	1	40	35	26	975035H	100	5708620211701
MMS-MS	7,5 x 40	6	5	40	35	26	975040H	100	5708620211718
MMS-MS	7,5 x 50	6	15	40	35	31,5	975050H	100	5708620201283

Fire classification: R120

MMS concrete bolt with countersunk head or pan head, zinc plated



TYPE	DIMENSION	d_0 [mm]	t_{fx} [mm]	h_1 [mm]	h_{nom} [mm]	h_{ef} [mm]	ART. NR.		EAN 13
MMS-F	6,0 x 40	5	10	35	30	19,5	906040U	200	5708620201313
MMS-F	6,0 x 60	5	15	50	45	32,3	906060U	100	5708620201320
MMS-F	6,0 x 80	5	35	55	45	32,3	906080U	50	5708620201337
MMS-P	5,0 x 30	4	1	35	30	20,5	905030P	200	5708620201290
MMS-P	5,0 x 50	4	15	40	35	24,8	905050P	200	5708620201306

• Not included in ETA-Assessment

MMS concrete bolt with eye (Ceiling anchor), Ø8, zinc plated



TYPE	DIMENSION	d_0 [mm]	t_{fx} [mm]	h_1 [mm]	h_{nom} [mm]	h_{ef} [mm]	ART. NR.		EAN 13
MMS-R	6 x 40	5	-	45	40	28,0	906040Ø	200	5708620201344

• Not included in ETA-Assessment

Through Bolt EXG II

Doorsteekanker EXG II

Bolzenanker EXG II

Cheville à expansion de type EXG II

Gennemstiksanker EXG II



concrete



FIXINGS FOR CONCRETE

Design resistance is valid for a single anchor in concrete C20/25 for EXG II (zinc plated & Hot Dipped Galvanized) and EXG-A4 II

DIAMETER	Standard Embedment depth		Reduced Embedment depth		Shallow Embedment depth		
	Tension load (kN)	Shear load (kN)	Tension load (kN)	Shear load (kN)	Shallow embedment depth* (mm)	Tension load* (kN)	Shear load* (kN)
M6 •	6,0 (5,0)	4,0 (5,6)	4,0	4,0 (5,6)	27	2,0	2,2
M8	8,0	8,8 (9,6)	6,0	6,9	35	2,8 (3,2)	3,2
M10	10,6	11,1	9,1 (8,0)	9,1	45 /52	4,0	4,6
M12	17,6 (16,7)	20,0 (21,6)	11,8	20,0 (21,6)	55	6,5	6,5
M16	24,0	33,0 (40,0)	17,2	33,0	65	9,0	18,0
M20	33,6	51,8 (61,4)	23,1	46,3	90	16,0	24,0

Conditions on load capacity: See page I, ref# 4

* Not part of the ETA-Assessment: valid for dimensions: 6 x 40 ;

10 x 60 ; 10 x 70 ; 12 x 75 ; 16 x 90 & 20 x 120

• M6 in Hot Dipped Galvanized is not included in ETA

() All the numbers in () are valid for EXG II A4

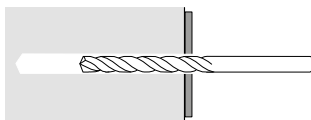
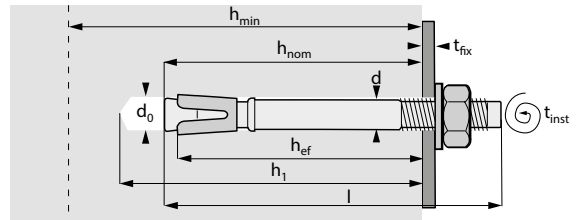

1]

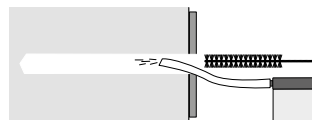

2]

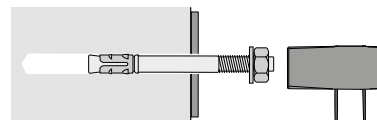

3]

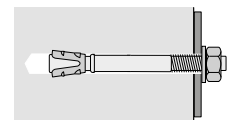

4]



DESIGN AND CALCULATE
YOUR ANCHORAGES IN THE
EXPANDET
CALCULATION
SOFTWARE!





<http://expandet.dk/en/downloads/>



Through Bolt EXG II, zinc plated



TYPE	DIMENSION	d _g [mm] 	STANDARD		REDUCED		ART. NR.		EAN 13
			t _{fix} [mm]	h ₁ [mm]	t _{fix} [mm]	h ₁ [mm]			
EXG II	6 x 40 *	6	5	35	5	35	0706040EG	100	5708620075211
EXG II	6 x 67	6	10	55	20	45	0706067EG	100	5708620075228
EXG II	6 x 97	6	40	55	50	45	0706097EG	100	5708620075235
EXG II	8 x 50 *	8	5	45	5	45	0708050EG	100	5708620075242
EXG II	8 x 60	8	4	55	4	55	0708060EG	100	5708620075259
EXG II	8 x 75	8	10	65	19	55	0708075EG	100	5708620075266
EXG II	8 x 95	8	30	65	39	55	0708095EG	100	5708620075273
EXG II	8 x 110	8	45	65	54	55	0708110EG	100	5708620075280
EXG II	8 x 165	8	55	65	109	55	0708165EG	50	5708620076171
EXG II	10 x 60 *	10	100	55	5	55	0710060EG	50	5708620075310
EXG II	10 x 70 *	10	5	60	10	60	0710070EG	50	5708620076195
EXG II	10 x 90	10	15	70	21	65	0710090EG	50	5708620075334
EXG II	10 x 105	10	30	70	36	65	0710105EG	50	5708620075341
EXG II	10 x 120	10	45	70	51	65	0710120EG	50	5708620075358
EXG II	10 x 145	10	60	70	66	65	0710145EG	50	5708620075365
EXG II	10 x 175	10	100	70	106	65	0710175EG	50	5708620075372
EXG II	10 x 215	10	140	70	146	65	0710215EG	25	5708620075389
EXG II	12 x 75 *	12	5	65	5	65	0712075EG	25	5708620075396
EXG II	12 x 110	12	15	90	30	75	0712110EG	25	5708620075402
EXG II	12 x 125	12	30	90	45	75	0712125EG	25	5708620075419
EXG II	12 x 145	12	50	90	65	75	0712145EG	25	5708620075426
EXG II	12 x 160	12	65	90	80	75	0712160EG	25	5708620075433
EXG II	12 x 180	12	85	90	100	75	0712180EG	25	5708620075440
EXG II	12 x 200	12	105	90	120	75	0712200EG	25	5708620075457
EXG II	12 x 240	12	145	90	160	75	0712240EG	20	5708620075464
EXG II	16 x 90 *	16	5	75	5	75	0716090EG	20	5708620075471
EXG II	16 x 115	16	13	95	13	95	0716115EG	20	5708620075488
EXG II	16 x 130	16	10	110	28	95	0716130EG	20	5708620075495
EXG II	16 x 150	16	30	110	48 (46)	95	0716150EG	20	5708620075501
EXG II	16 x 180	16	60	110	78	95	0716180EG	20	5708620075518
EXG II	16 x 220	16	100	110	118	95	0716220EG	10	5708620075525
EXG II	16 x 250	16	130	110	148	95	0716250EG	10	5708620075532
EXG II	16 x 285	16	165	110	183	95	0716285EG	10	5708620075549
EXG II	16 x 320	16	200	110	218	95	0716320EG	10	5708620075556
EXG II	20 x 120	20	10	100	10	100	0720120EG	10	5708620075563
EXG II	20 x 180	20	35	130	57	120	0720180EG	10	5708620075570
EXG II	20 x 205	20	60	130	82	120	0720205EG	10	5708620075587

ETA, Option 7, CE-marked



Fire resistance classification R120 (120 minutes)

VDS approved: M8-M10

* Is not included in ETA, reduced embedment depth

Through Bolt EXG II, Hot Dip Galvanized

FIXINGS FOR CONCRETE

TYPE	DIMENSION	d ₀ [mm] 	STANDARD		REDUCED		ART. NR.		EAN 13
			t _{fix} [mm]	h ₁ [mm]	t _{fix} [mm]	h ₁ [mm]			
EXG II	6 x 40 *	6	5	35	5	35	0706040VG	100	5708620075594
EXG II	6 x 67	6	10	55	20	45	0706067VG	100	5708620075600
EXG II	6 x 97	6	40	55	50	45	0706097VG	100	5708620075617
EXG II	8 x 50 *	8	5	45	5	45	0708050VG	100	5708620075624
EXG II	8 x 60	8	4	55	4	55	0708060VG	100	5708620075631
EXG II	8 x 75	8	10	65	19	55	0708075VG	100	5708620075648
EXG II	8 x 95	8	30	65	39	55	0708095VG	100	5708620075655
EXG II	8 x 110	8	45	65	54	55	0708110VG	100	5708620075662
EXG II	8 x 165	8	55	65	109	55	0708165VG	50	5708620075686
EXG II	10 x 60 *	10	100	55	5	55	0710060VG	50	5708620075693
EXG II	10 x 70 *	10	5	60	10	60	0710070VG	50	5708620076201
EXG II	10 x 90	10	15	70	21	65	0710090VG	50	5708620075709
EXG II	10 x 105	10	30	70	36	65	0710105VG	50	5708620075716
EXG II	10 x 120	10	45	70	51	65	0710120VG	50	5708620075723
EXG II	10 x 145	10	60	70	66	65	0710145VG	50	5708620075730
EXG II	10 x 175	10	100	70	106	65	0710175VG	50	5708620075747
EXG II	10 x 215	10	140	70	146	65	0710215VG	25	5708620075754
EXG II	12 x 75 *	12	5	65	5	65	0712075VG	25	5708620075761
EXG II	12 x 110	12	15	90	30	75	0712110VG	25	5708620075778
EXG II	12 x 125	12	30	90	45	75	0712125VG	25	5708620075785
EXG II	12 x 145	12	50	90	65	75	0712145VG	25	5708620075792
EXG II	12 x 160	12	65	90	80	75	0712160VG	25	5708620075808
EXG II	12 x 180	12	85	90	100	75	0712180VG	25	5708620075815
EXG II	12 x 200	12	105	90	120	75	0712200VG	25	5708620075822
EXG II	12 x 240	12	145	90	160	75	0712240VG	20	5708620075839
EXG II	16 x 90 *	16	5	75	5	75	0716090VG	20	5708620075846
EXG II	16 x 115	16	13	95	13	95	0716115VG	20	5708620075853
EXG II	16 x 130	16	10	110	28	95	0716130VG	20	5708620075860
EXG II	16 x 150	16	30	110	48 (46)	95	0716150VG	20	5708620075877
EXG II	16 x 180	16	60	110	78	95	0716180VG	20	5708620075884
EXG II	16 x 220	16	100	110	118	95	0716220VG	10	5708620075891
EXG II	16 x 250	16	130	110	148	95	0716250VG	10	5708620075907
EXG II	16 x 285	16	165	110	183	95	0716285VG	10	5708620075914
EXG II	16 x 320	16	200	110	218	95	0716320VG	10	5708620075921
EXG II	20 x 120	20	10	100	10	100	0720120VG	10	5708620075938
EXG II	20 x 180	20	35	130	57	120	0720180VG	10	5708620075945
EXG II	20 x 205	20	60	130	82	120	0720205VG	10	5708620075952

ETA, Option 7, CE-marked

Fire resistance classification R120 (120 minutes)



VDS approved: M8-M10

* Is not included in ETA, reduced embedment depth



Through Bolt EXG-A4 II, Stainless steel A4 (316)



TYPE	DIMENSION	d ₀ [mm] 	STANDARD		REDUCED		ART. NR.		EAN 13
			t _{fix} [mm]	h ₁ [mm]	t _{fix} [mm]	h ₁ [mm]			
EXG II	6 x 40 *	6	5	35	5	35	0706040A4	100	5708620075969
EXG II	6 x 67	6	10	55	20	45	0706067A4	100	5708620075976
EXG II	8 x 50 *	8	5	45	5	45	0708050A4	100	5708620075983
EXG II	8 x 60	8	4	55	4	55	0708060A4	100	5708620075990
EXG II	8 x 75	8	10	65	19	55	0708075A4	100	5708620076003
EXG II	8 x 95	8	30	65	39	55	0708095A4	100	5708620076010
EXG II	8 x 110	8	45	65	54	55	0708110A4	100	5708620076027
EXG II	10 x 60 *	10	100	55	5	55	0710060A4	50	5708620076034
EXG II	10 x 90	10	15	70	21	65	0710090A4	50	5708620076041
EXG II	10 x 105	10	30	70	36	65	0710105A4	50	5708620076058
EXG II	10 x 120	10	45	70	51	65	0710120A4	50	5708620076065
EXG II	10 x 145	10	60	70	66	65	0710145A4	50	5708620076072
EXG II	12 x 75 *	12	5	65	5	65	0712075A4	25	5708620076089
EXG II	12 x 110	12	15	90	30	75	0712110A4	25	5708620076096
EXG II	12 x 125	12	30	90	45	75	0712125A4	25	5708620076102
EXG II	12 x 145	12	50	90	65	75	0712145A4	25	5708620076119
EXG II	12 x 160	12	65	90	80	75	0712160A4	25	5708620076126
EXG II	16 x 115	16	13	95	13	95	0716115A4	20	5708620076133
EXG II	16 x 150	16	30	110	48 (46)	95	0716150A4	20	5708620076140
EXG II	20 x 180	20	35	130	57	120	0720180A4	10	5708620076157
EXG II	20 x 205	20	60	130	82	120	0720205A4	10	5708620076164

ETA, Option 7, CE-marked
 Fire resistance classification R120 (120 minutes)
 VDS approved: M8-M10

FIXINGS FOR CONCRETE



Through Bolt BZ

Doorsteekanker BZ

Bolzenanker BZ

Cheville à expansion de type BZ

Gennemstiksanker BZ



FIXINGS FOR CONCRETE

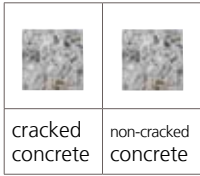

Type	Design load capacities				
DIAMETER	h_{nom} [mm]	Non-cracked concrete		Cracked concrete	
		Tension load N_{Rd}	Shear load V_{Rd}	Tension load N_{Rd}	Shear load V_{Rd}
M8	60 (52)	6,4 (6,0)	12,0 (10,4)	3,3	12,0 (10,4)
M10	75 (67)	7,7 (8,0)	17,6 (16,0)	6,0	17,6 (16,0)
M12	90 (80)	13,4	24,0	10,6 (10,7)	24,0
M16	110 (95)	20,0	48,0 (44,0)	16,6	37,6

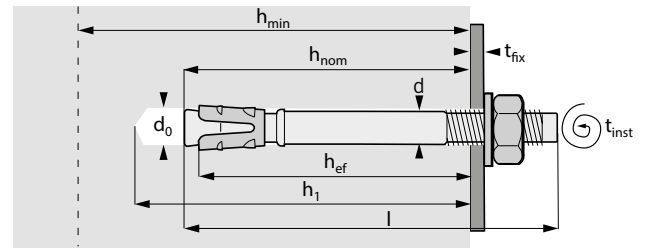

0) Loads in () are only valid for BZ - A4 stainless steel.

Conditions on load capacity: See page 1, ref# 4

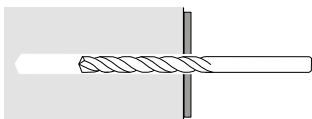

1]

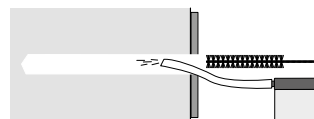

2]

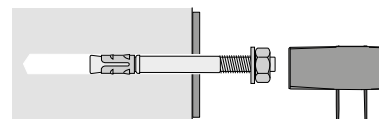

3]

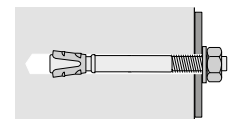

4]



Seismic C1 & C2



Option 1 in concrete



Fire classified R120



Swiss shock Approval

DESIGN AND CALCULATE
YOUR ANCHORAGES IN THE
EXPANDET
CALCULATION
SOFTWARE!



<http://expandet.dk/en/downloads/>



Through Bolt BZ, zinc plated



TYPE	DIMENSION	d ₀ [mm]	STANDARD	
			t _{fix} [mm]	h ₁ [mm]
BZ	8 x 75	8	10	60
BZ	8 x 95	8	30	60
BZ	8 x 115	8	50	60
BZ	10 x 90	10	10	75
BZ	10 x 95	10	20	75
BZ	10 x 110	10	30	75
BZ	10 x 130	10	50	75
BZ	12 x 115	12	20	90
BZ	12 x 125	12	30	90
BZ	12 x 145	12	50	90
BZ	12 x 160	12	65	90
BZ	12 x 180	12	85	90
BZ	12 x 200	12	105	90
BZ	12 x 220	12	125	90
BZ	12 x 240	12	145	90
BZ	12 x 255	12	160	90
BZ	16 x 135	16	15	110
BZ	16 x 145	16	25	110
BZ	16 x 170	16	50	110
BZ	16 x 220	16	100	110
BZ	16 x 260	16	140	110
BZ	16 x 300	16	180	110

ART. NR.		EAN 13
708075BZ	100	5708620074696
708095BZ	100	5708620074702
708115BZ	100	5708620074719
710090BZ	50	5708620074726
710095BZ	50	5708620074733
710110BZ	50	5708620074740
710130BZ	50	5708620074757
712115BZ	25	5708620074764
712125BZ	25	5708620075150
712145BZ	25	5708620074771
712160BZ	25	5708620075167
712180BZ	25	5708620074788
712200BZ	25	5708620075174
712220BZ	25	5708620074795
712240BZ	20	5708620074801
712255BZ	20	5708620074818
716135BZ	20	5708620075181
716145BZ	20	5708620074825
716170BZ	20	5708620074832
716220BZ	10	5708620074849
716260BZ	10	5708620074856
716300BZ	10	5708620074863

M20 & M24 BZ-Throughbolts, zinc plated are available on request.

ETA, Option 1, CE-marked

Fire resistance classification: R120

M8-M24 (Swiss shock Approval)

Throughbolt BZ-A4 stainless steel



FIXINGS FOR CONCRETE

TYPE	DIMENSION	*	d ₀ [mm]	STANDARD	
				t _{fix} [mm]	h ₁ [mm]
BZ-A4	8 x 75	*	8	10	60
BZ-A4	8 x 95	*	8	30	60
BZ-A4	8 x 115	*	8	50	60
BZ-A4	10 x 90	*	10	10	75
BZ-A4	10 x 95	*	10	15	75
BZ-A4	10 x 110	*	10	30	75
BZ-A4	10 x 130	*	10	50	75
BZ-A4	12 x 110	*	12	15	90
BZ-A4	12 x 115	*	12	20	90
BZ-A4	12 x 125	*	12	30	90
BZ-A4	12 x 145	*	12	50	90
BZ-A4	12 x 180	*	12	85	90
BZ-A4	12 x 220	*	12	125	90
BZ-A4	16 x 140	*	16	25	110
BZ-A4	16 x 170	*	16	50	110
BZ-A4	16 x 215	*	16	100	110

ART. NR.			EAN 13
708075BZA4	100		5708620074870
708095BZA4	100		5708620074887
708115BZA4	100		5708620074894
710090BZA4	50		5708620074900
710095BZA4	50		5708620074917
710110BZA4	50		5708620074924
710130BZA4	50		5708620074931
712110BZA4	25		5708620075198
712115BZA4	25		5708620074948
712125BZA4	25		5708620075204
712145BZA4	25		5708620074955
712180BZA4	25		5708620074962
712220BZA4	25		5708620074979
716140BZA4	20		5708620074986
716170BZA4	20		5708620074993
716215BZA4	10		5708620075006

* Available on request
 M20 BZ-A4 Throughbolts are available on request
 ETA, Option 1, CE-marked
 Fire resistance classification: R120
 M8-M24 (Swiss shock Approval)



Heavy Duty Anchor SZ-S

Zwaarlastanker, SZ-S

Hochleistungsanker SZ-S

Ancrage pour charge lourde SZ-S

Sværlastanker SZ-S



FIXINGS FOR CONCRETE

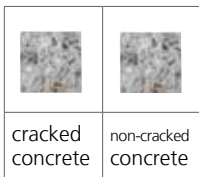

Type	Design load capacities					
	DIAMETER	h_{nom} [mm]	Non-cracked concrete		Cracked concrete	
			Tension load N_{Rd}	Shear load V_{Rd}	Tension load N_{Rd}	Shear load V_{Rd}
M6	60	8,0	14,1	3,3	14,1	
M8	70	10,6	23,9	8,0	22,3	
M10	85	16,6	38,5	10,6	28,7	
M12	95	20,0	48,0	17,7	34,3	
M16	120	26,6	67,2	24,0	48,0	
M20	150	33,0	93,9	33,0	67,0	

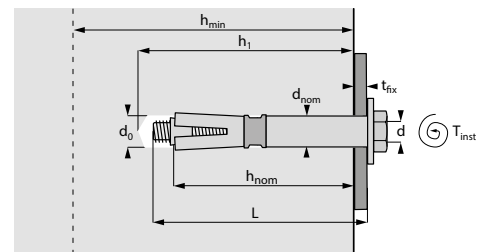

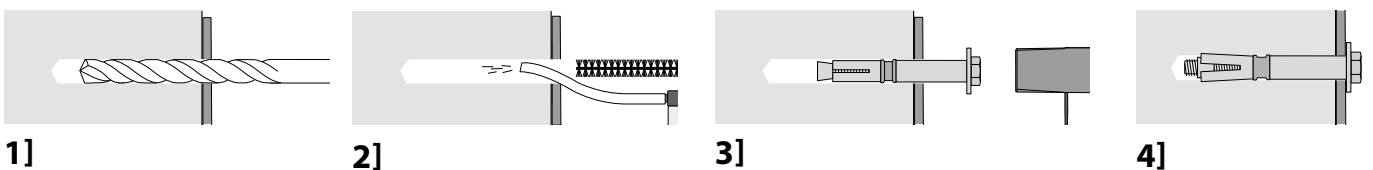

Conditions on load capacity: See page I, ref# 4



Heavy Duty Anchor SZ-S



FIXINGS FOR CONCRETE

TYPE	DIMENSION	d ₀ [mm] 	h ₁ [mm]	t _{fix} [mm]	ART. NR.		EAN 13
SZ-S 10/10	6 x 70	10	65	10	SZS1010	50	5708620075013
SZ-S 10/30	6 x 90	10	65	30	SZS1030	50	5708620075020
SZ-S 10/50	6 x 110	10	65	50	SZS1050	50	5708620075037
SZ-S 12/10	8 x 80	12	80	10	SZS1210	50	5708620075044
SZ-S 12/30	8 x 100	12	80	30	SZS1230	50	5708620075051
SZ-S 12/50	8 x 120	12	80	50	SZS1250	25	5708620075068
SZ-S 15/15	10 x 100	15	95	15	SZS1515	25	5708620075075
SZ-S 15/25	10 x 110	15	95	25	SZS1525	25	5708620075082
SZ-S 15/45	10 x 130	15	95	45	SZS1545	25	5708620075099
SZ-S 18/10	12 x 110	18	105	10	SZS1810	20	5708620075105
SZ-S 18/20	12 x 120	18	105	20	SZS1820	20	5708620075112
SZ-S 18/40	12 x 140	18	105	40	SZS1840	20	5708620075129
SZ-S 24/20	16 x 140	24	130	20	SZS2420	10	5708620075136
SZ-S 24/50	16 x 170	24	130	50	SZS2450	10	5708620075143

M20 (SZ-S 28), available on request
 ETA, Option 1, CE-marked
 Fire resistance classification: R120.
 VDS Approval: M8-M20
 M8-M20 Swiss Shock Approval



Seismic C1 & C2



Option 1 in concrete



Fire classified R120



VdS



Swiss shock Approval

Drop In Anchor E

Inslaganker E
Einschlaganker E
Cheville à expansion de type E
Slaganker E



FIXINGS FOR CONCRETE

Type	h ₁ [mm]	Design load capacities	
		N _{Rd}	V _{Rd}
		Tension load kN	Shear load kN
M6	30	4,60 (4,60)	4,00 (4,50)
M8	30	3,90 (4,60)	5,50 (6,40)
M10	40	7,10 (8,50)	5,70 (8,30)
M12	50	9,90 (11,80)	16,80 (16,60)
M16	65	14,60 (17,60)	25,10 (26,90)
M20	80	20,00 (24,00)	40,00 (42,90)

() Values in () are valid for Drop in Anchor E Inox A4 , with A4-70 screw.
Conditions on load capacity: See page I, ref# 4.

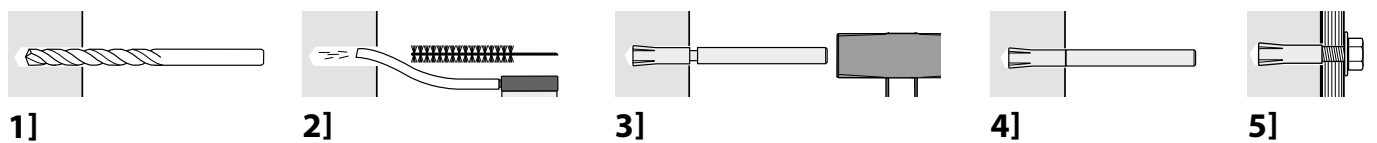
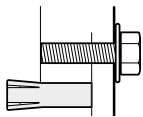

DESIGN AND CALCULATE
YOUR ANCHORAGES IN THE
EXPANDET
CALCULATION
SOFTWARE!



<http://expandet.dk/en/downloads/>



Drop In Anchor E, zinc plated



TYPE	DIMENSION	d ₀ [mm]	h ₁ [mm]	MIN. SCREW IN DEPTH [mm]	ART. NR.		EAN 13
E	6 x 30	8	30	7	77031	100	5708620097251
E	8 x 30	10	30	9	77032	100	5708620097268
E	10 x 40	12	40	11	77035	50	5708620209364
E	12 x 50	15	50	13	77034	50	5708620097282
E	16 x 65	20	65	18	77039	25	5708620097299
E	20 x 80	25	80	22	77040	20	5708620097305

ETA, Option 7, CE-marked

Fire classification: R120

VDS Approval: M8-M12

Drop In Anchor E, Inox A4 (316)



TYPE	DIMENSION	d ₀ [mm]	h ₁ [mm]	MIN. SCREW IN DEPTH [mm]	ART. NR.		EAN 13
E-A4	6 x 30	8	30	7	77031 R	100	5708620099767
E-A4	8 x 30	10	30	9	77032 R	100	5708620099774
E-A4	10 x 40	12	40	11	77035 R	50	5708620209371
E-A4	12 x 50	15	50	13	77034 R	50	5708620099798
E-A4	16 x 65	20	65	18	77039 R	25	5708620099804
E-A4	20 x 80	25	80	22	77040 R	20	5708620099811

ETA, Option 7, CE-marked

Fire classification: R120

VDS Approval: M8-M12

Setting tool for Drop In Anchor



TYPE
For Drop In Anchor:

M6
M8
M10
M12
M16
M20

ART. NR.		EAN 13
977950	1	5708620096803
977951	1	5708620096810
977952	1	5708620096827
977953	1	5708620096834
977954	1	5708620096872
977955	1	5708620097312



Drop In Anchor K

Inslag anker K
Einschlaganker K
Cheville à expansion de type K
Slaganker K



FIXINGS FOR CONCRETE



Type	h ₁ [mm]	Design load capacities	
		N _{Rd}	V _{Rd}
DIMENSION		Tension load kN	Shear load kN
M12	53	8,50	5,60
M16	65	14,00	8,80

Conditions on load capacity: See page I, ref# 4.

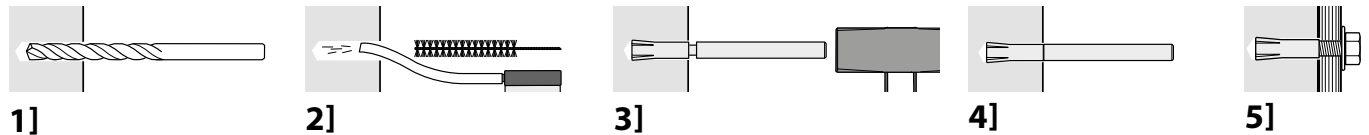
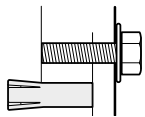

TYPE	DIMENSION	d ₀ [mm]	h ₁ [mm]
M12 with collar	12 x 50	16	53
M16 with collar *	16 x 60	20	65
M12 without collar	12 x 50	16	53
M16 without collar *	16 x 60	20	65

* Going out of range

ART. NR.		EAN 13
77044K	50	5708620203331
77049K	25	5708620203348
77034K	50	5708620201764
77039K	25	5708620202785

Setting tool for Drop In Anchor



TYPE	DIMENSION
For Drop In Anchor:	
M12	
M16	

ART. NR.		EAN 13
977953	1	5708620096834
977954	1	5708620096872

Concrete Hammer Rivet

Cellen Keilnagel
 Beton Deckennagel
 Clou à béton cellulaire
 Betonslagpløk





FIXINGS FOR CONCRETE

Type	Load capacities
DIMENSION	F_{rec}
	Recommended combined load kN
6 x 35	1,19
6 x 65	1,19

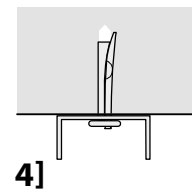
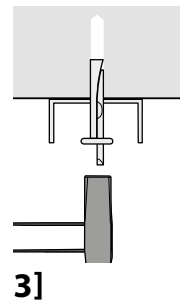
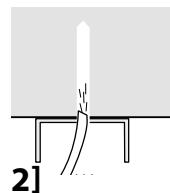
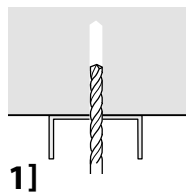
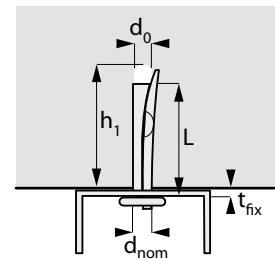
Conditions on load capacity: See page I, ref# 4.



TYPE	h [mm] CONCRETE	d_0 [mm] 	h_1 [mm]	t_{fix} [mm]	ART. NR.		EAN 13
6 x 35	80	6	40	4,5	960640	100	5708620099743
6 x 65	80	6	40	35,0	960670	100	5708620099750

ETA, Part 6
 Fire resistance: R120



Ceiling Anchor

Plafond Anker
 Deckenanker
 Goupille d'ancrage
 Loftsancker



FIXINGS FOR CONCRETE

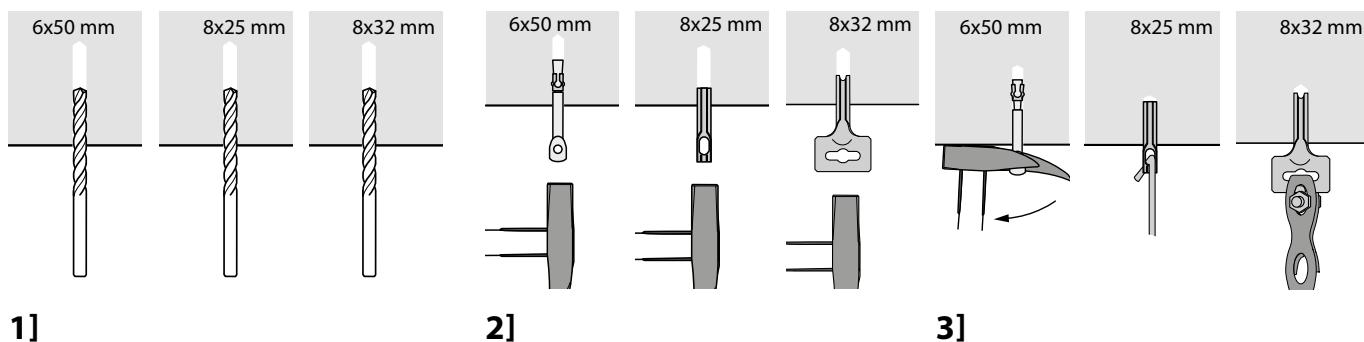

Type	Load capacities
DIMENSION	N_{rec}
	Recommended Tension load kN
6 x 50	1,35
8 x 25	1,00
8 x 32	1,00

Conditions on load capacity: See page I, ref# 4.





Ceiling Anchor, hardened spring steel, black phosphated



TYPE	d ₀ [mm] 	h ₁ [mm]	ART. NR.		EAN 13
8 x 25	8	22	968025	100	5708620097237



Ceiling Anchor, hardened spring steel, zinc plated



TYPE	d ₀ [mm] 	h ₁ [mm]	ART. NR.		EAN 13
8 x 32	8	30	968032	100	5708620096599

Ceiling Anchor, steel, zinc plated



TYPE	d ₀ [mm] 	h ₁ [mm]	ART. NR.		EAN 13
6 X 50	6	35	055660	100	5708620097244

ExtremeCut 3+ Drill bit

ExtremeCut 3+ boor
Hammerbohrer ExtremeCut 3+
Mêche ExtremeCut 3+
ExtremeCut 3+

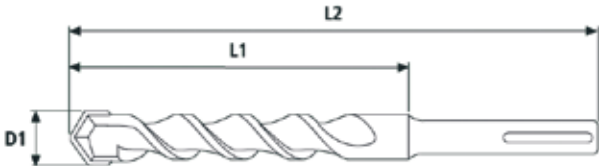

DRILLS



ExtremeCut 3+ Drill bit



EXTREME CUT 3+, 3 CUTTER SDS

TYPE
5,0 x 110
6,0 x 110
8,0 x 110
5,0 x 160
6,0 x 160
6,5 x 160
7,0 x 160
8,0 x 160
10,0 x 160
12,0 x 160
14,0 x 160
15,0 x 160
16,0 x 160
6,0 x 210
6,5 x 210
7,0 x 210
8,0 x 210
10,0 x 210
12,0 x 210
14,0 x 210
15,0 x 210
16,0 x 210
18,0 x 210
20,0 x 210
10,0 x 260
14,0 x 260
6,0 x 310
6,5 x 310
8,0 x 310
10,0 x 310
12,0 x 310
14,0 x 310
15,0 x 310
16,0 x 310
18,0 x 310
20,0 x 310
8,0 x 460
10,0 x 460
12,0 x 460
14,0 x 460
15,0 x 460
16,0 x 460
18,0 x 460
20,0 x 460
10,0 x 610
12,0 x 610
14,0 x 610

L ₁ [mm]	ART. NR.			EAN 13
50	93050110	1		5708620103099
50	93060110	1		5708620103143
50	93080110	1		5708620103204
100	93050160	1		5708620103105
100	93060160	1		5708620103150
100	93065160	1		5708620103112
100	93070160	1		5708620103181
100	93080160	1		5708620103211
100	93100160	1		5708620103259
100	93120160	1		5708620103310
100	93140160	1		5708620103365
100	93150160	1		5708620103426
100	93160160	1		5708620103464
150	93060210	1		5708620103167
150	93065210	1		5708620103129
150	93070210	1		5708620103198
150	93080210	1		5708620103228
150	93100210	1		5708620103266
150	93120210	1		5708620103327
150	93140210	1		5708620103372
150	93150210	1		5708620103433
150	93160210	1		5708620103471
150	93180210	1		5708620103501
150	93200210	1		5708620103532
200	93100260	1		5708620103273
200	93140260	1		5708620103389
250	93060310	1		5708620103174
250	93065310	1		5708620103136
250	93080310	1		5708620103235
250	93100310	1		5708620103280
250	93120310	1		5708620103334
250	93140310	1		5708620103396
250	93150310	1		5708620103440
250	93160310	1		5708620103488
250	93180310	1		5708620103518
250	93200310	1		5708620103549
400	93080460	1		5708620103242
400	93100460	1		5708620103297
400	93120460	1		5708620103341
400	93140460	1		5708620103402
400	93150460	1		5708620103457
400	93160460	1		5708620103495
400	93180460	1		5708620103525
400	93200460	1		5708620103556
550	93100610	1		5708620103303
550	93120610	1		5708620103358
550	93140610	1		5708620103419

DRILLS

ExtremeCut 3+ Drill bit

EXTREMECUT 3+, 3 CUTTER SDS, 12 pcs. per box

TYPE	L ₁ [mm]	ART. NR.		EAN 13
6,0 x 160	100	93060160/12	12	5708620103563
6,5 x 160	100	93065160/12	12	5708620103587
8,0 x 160	100	93080160/12	12	5708620103600
10,0 x 160	100	93100160/12	12	5708620103624
14,0 x 160	100	93140160/12	12	5708620103655
6,0 x 210	150	93060210/12	12	5708620103570
6,5 x 210	150	93065210/12	12	5708620103594
8,0 x 210	150	93080210/12	12	5708620103617
10,0 x 210	150	93100210/12	12	5708620103631
12,0 x 210	150	93120210/12	12	5708620103648
14,0 x 210	150	93140210/12	12	5708620103662

Ultimax SDS Max

Ultimax SDS Max boor
 Hammerbohrer Ultimax SDS Max
 Mèche Ultimax SDS Max
 Ultimax SDS Max

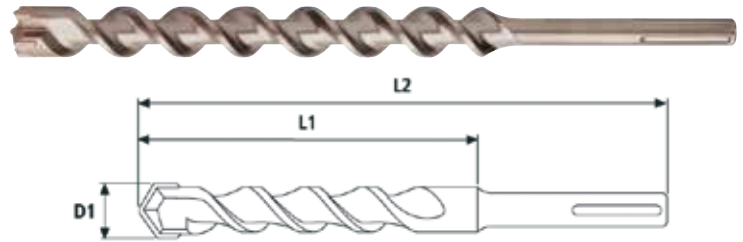

ULTIMAX SDS MAX, 6 CUTTER

TYPE

15,0 x 340	*
16,0 x 340	
18,0 x 340	
20,0 x 340	
22,0 x 340	
25,0 x 340	
28,0 x 340	
32,0 x 340	
35,0 x 340	

15,0 x 540	*
16,0 x 540	
18,0 x 540	
20,0 x 540	
22,0 x 540	
25,0 x 540	
28,0 x 540	
32,0 x 540	
35,0 x 540	

16,0 x 690	
18,0 x 690	
20,0 x 690	
22,0 x 690	
28,0 x 690	
32,0 x 690	
22,0 x 920	
25,0 x 920	
28,0 x 920	
32,0 x 920	

* 3 CUTTER

L ₁ [mm]	ART. NR.		EAN 13
200	96150340	1	3336600004832
200	96160340	1	3336600004849
200	96180340	1	3336600004856
200	96200340	1	3336600004870
200	96220340	1	3336600004887
200	96250340	1	3336600004900
200	96280340		3336600068261
200	96320340	1	3336600068278
200	96350340	1	3336600054707
400	96150540	1	3336600004948
400	96160540	1	3336600004955
400	96180540	1	3336600005136
400	96200540	1	3336600005150
400	96220540	1	3336600005167
400	96250540	1	3336600005181
400	96280540	1	3336600005204
400	96320540	1	3336600005235
400	96350540	1	3336600005242
550	96160690	1	3336600005327
550	96180690	1	3336600005334
550	96200690	1	3336600005358
550	96220690	1	3336600005365
550	96280690	1	3336600005402
550	96320690	1	3336600005433
780	96220920	1	3336600005501
780	96250920	1	3336600005525
780	96280920	1	3336600005549
780	96320920	1	3336600005570

DRILLS

Masonry Drill Bits with SDS S4 PLUS

Baksteen SDS S4 PLUS boor
 Bohrereinsätze für Mauerwerk mit SDS S4 PLUS
 Mèche pour béton avec SDS S4 PLUS
 Murbor med SDS S4 Plus

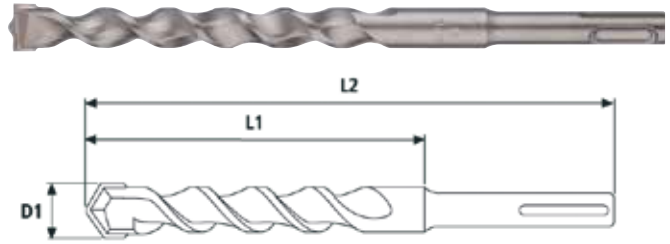

LEGEND

- L1 = Effective length
- L2 = Total length
- D1 = Drill
- D2 = Shaft diameter



DRILLS

Drill diameter x length

DESCRIPTION		
D1 [mm]	L1 [mm]	L2 [mm]
5	50	110
6	50	110
8	50	110
5	100	160
6	100	160
7	100	160
8	100	160
10	100	160
12	100	160
13	100	160
14	100	160
15	100	160
16	100	160
6	150	210
8	150	210
10	150	210
12	150	210
13	150	210
14	150	210
15	150	210
16	150	210
18	150	210
20	150	210
22	150	210
24	150	210
25	150	210
6	200	260
8	200	260
10	200	260
12	200	260
13	200	260
14	200	260
15	200	260
16	200	260

ART. NR.			EAN 13
12305L0110			
12306L0110			
12308L0110			
12305L0160			
12306L0160			
12307L0160			
12308L0160			
12310L0160			
12312L0160			
12313L0160			
12314L0160			
12315L0160			
12316L0160			
12306L0210			
12308L0210			
12310L0210			
12312L0210			
12313L0210			
12314L0210			
12315L0210			
12316L0210			
12318L0210			
12320L0210			
12322L0210			
12324L0210			
12325L0210			
12306L0260			
12308L0260			
12310L0260			
12312L0260			
12313L0260			
12314L0260			
12315L0260			
12316L0260			

DESCRIPTION		
D1 [mm]	L1 [mm]	L2 [mm]
18	200	260
20	200	260
22	200	260
24	200	260
25	200	260
6	250	310
8	250	310
10	250	310
12	250	310
13	250	310
14	250	310
15	250	310
16	250	310
18	250	310
20	250	310
22	250	310
24	250	310
25	250	310
8	400	460
10	400	460
12	400	460
14	400	460
16	400	460
18	400	460
20	400	460
22	400	460
24	400	460
25	400	460
8	550	610
10	550	610
12	550	610
14	550	610
16	550	610
18	550	610
20	550	610
22	550	610
25	550	610
8	940	1000
10	940	1000
12	940	1000
14	940	1000
16	940	1000
18	940	1000
20	940	1000

ART. NR.			EAN 13
12318L0260			
12320L0260			
12322L0260			
12324L0260			
12325L0260			
12306L0310			
12308L0310			
12310L0310			
12312L0310			
12313L0310			
12314L0310			
12315L0310			
12316L0310			
12318L0310			
12320L0310			
12322L0310			
12324L0310			
12325L0310			
12308L0460			
12310L0460			
12312L0460			
12314L0460			
12316L0460			
12318L0460			
12320L0460			
12322L0460			
12324L0460			
12325L0460			
12308L0610			
12310L0610			
12312L0610			
12314L0610			
12316L0610			
12318L0610			
12320L0610			
12322L0610			
12325L0610			
12308L1000			
12310L1000			
12312L1000			
12314L1000			
12316L1000			
12318L1000			
12320L1000			

DRILLS

All technical details may be subject to changes without notice. We do not accept liability for printing mistakes or omissions.

© Verpa Senco B.V., 2017_2. All rights reserved.

Expandet C-Bolt pour des fixations rapides à forte charge

L'innovatif C-Bolt est un ancrage pour béton conçu pour des fixations instantanées avec forte charge. Il a une tête large permettant une fixation dans le béton fissuré ou non-fissuré et aussi dans le béton léger.

Cet ancrage multi-fonction peut être utilisé pour la fixation de supports, balustrades de balcons, de machines, de poutrelles en bois et acier, etc.

Il combine une installation très rapide avec une force d'ancrage immédiate. Les configurations d'ancrage pour le C-bolt sont incluses dans le software de calcul Expandet selon les directives de l'ETAG.

Avantages

- Différences en profondeurs d'ancrage pour un maximum de flexibilité
- Résistance au feu R120
- Sans expansion, peut être utilisé près du bord
- Avec tête large, pas de rondelle nécessaire
- Amovible
- Charge immédiate avec haute résistance
- Petite profondeur d'encastement
- Les configurations d'ancrage pour la C-Bolt sont incluses dans le programme de calcul Expandet.



	EN	NL	DE	FR	DK
	Base materials	Basismaterialen	Befestigungsuntergrunde	Matériaux de base	Basismaterialer
	Aerated concrete	Cellenbeton	Gasbeton	Béton cellulaire	Porebeton
	Breeze	Geplet grind	Poren	Gravier concassé	Breeze
	Cavity walls	Spouwmuren	Hohlraumwände	Murs creux	Hulrumsvæg
	Chipboards	Spaanplaten	Spanplatten	Attaches	Spånplade
	Cracked concrete	Gescheurd beton	Gerissener Beton	Béton fissuré	Revnet beton
	Concrete	Beton	Beton	Béton fissuré	Beton
	Concrete block	Betonblok	Betonstein	Bloc de béton	Beton sten
	Constructions with cavities	Constructies met holtes	Hohlraumkonstruktionen	Constructions creuses	Konstruktion med hulrum
	Gypsum fiber boards	Gipsvezelplaten	Gipsfaserplatten	Panneaux de plaque de plâtre	Fibergips
	Hollow brick	Holle baksteen	Hohllochziegel	Brique creuse	Hulsten
	Hollow concrete block	Holle betonblok	Betonhohlblockstein	Bloc de béton creux	Betonhulsten
	Lightweight blocks	Lichte gipsplaten	Leichtbausteine	Blocs légers	Lav-densitet sten
	Materials with cavities	Materialen met holtes	Baustoffe mit Hohlräumen	Blocs	Materialer med hulrum
	Natural stone	Natuurlijke gesteente	Naturstein	Matériaux creux	Natursten
	Non-cracked concrete	Niet gescheurd beton	Ungerissener Beton	Pierre naturelle	Ikke revnet beton
	Perforated sand-lime stone	Geperforeerde kalkzandsteen	Kalksandstein mit porigem Gefüge	Béton non-fissuré	Hulsten, Kalksandsten
	Plasterboard	Gisplaten	Gipskartonplatten	Pierre fissurée et poreuse	Gipsplader
	Porous materials	Poreus materiaal	Baustoffe mit porigem Gefüge	Plaques de plâtre	Porøse materialer
	Porous walls	Poreuse wanden	Mauerwerk mit porigem Gefüge	Matériaux poreux	Porøse vægge
	Two- and three-layer plasterboards	Twée en drie laags gipsplaten	Zwei- und dreilagige Gipskartonplatten	Deux à trois couches de plaques de plâtre	To- og tre laags gips
	Sand lime brick	Kalkzandsteen	Kalksandstein	Briques calcaires	Kalksandsten
	Solid base materials	Massieve basis materialen	Druckfestes Material	Base de matériaux durs	Massive materialer
	Solid brick	Massieve baksteen	Vollziegel	Brique dure	Massiv sten
	Solid materials	Massief materiaal	Druckfestes Material	Matériaux durs	Massive materialer
	Wood	Hout	Holz	Bois	Træ

Software de calcul Expandet

Le software de calcul Expandet (ECF) est un programme 3D de calcul d'ancrage très performant, développé pour répondre à toutes les exigences demandées par les utilisateurs professionnels et aussi pour les utilisateurs moins expérimentés, travaillant avec les systèmes d'ancrage.

En complétant simplement un certain nombre de données, le programme propose automatiquement à l'utilisateur un choix d'ancrages correspondant.

Entièrement gratuit

ECS est un programme téléchargeable gratuitement, il contient une série d'options qui fournissent à l'utilisateur une série de solutions uniques pour la fixation dans le béton. Un système complet qui vous aide à trouver le produit d'ancrage adéquat.

Exigences spécifiques

Le programme peut aussi aider sur d'autres contraintes de la construction comme par exemple pour les exigences pour les zones sismiques, les demandes spécifiques pour un ancrage mécanique ou chimique, l'utilisation de produits résistants au feu et tout type d'acier différent.

Pour répondre à une demande particulièrement efficace et économique, une fonction appelée "Optimisation profondeur", peut ajuster la profondeur d'ancrage le plus précisément possible tout en offrant une garantie pour répondre aux exigences demandées.

Après avoir inséré toutes les données, l'utilisateur recevra un document PDF complet et clair, contenant tous les détails de calculs avec y compris:

- La photo et la dénomination de l'ancrage
- L'approbation concernée
- L'utilisation en %

**DESIGN AND
CALCULATE**
YOUR ANCHORAGES IN THE
EXPANDET
CALCULATION
SOFTWARE!



<http://expandet.dk/en/downloads/>



EXPANDET 

A **SENGO** BRAND